

SERVICE MANUAL

MULTI VARIABLE SERIES DUCT

MV-DxxBI



“Original instructions”

IMPORTANT NOTE:

Read this manual carefully before installing or operating your new air conditioning unit. Make sure to save this manual for future reference.

Table of Contents

Part I : Technical Information	1
1. Summary	1
2. Specifications	2
3. Outline Dimension Diagram	6
4. Refrigerant System Diagram	7
5. Electrical Part	8
5.1 Wiring Diagram.....	8
5.2 PCB Printed Diagram	9
6. Function and Control	10
6.1 Remote Controller Introduction	10
6.2 Brief Description of Modes and Functions.....	14
6.3 Wired Remote Controller XK19	16
Part II : Installation and Maintenance	25
7. Indoor Unit Installation	25
8. Maintenance	36
8.1 Error Code List	36
8.2 Troubleshooting for Main Malfunction	37
9. Exploded View and Parts List	41
10. Removal Procedure	47

Part I : Technical Information

1. Summary

Indoor Unit

MV-D09BI
MV-D12BI
MV-D18BI
MV-D24BI



Remote Controller

YT1F(MOTO)



2. Specifications

2.1 Specification Sheet

Parameter		Unit	Value	
Model			MV-D09BI	MV-D12BI
Product Code			CN210N0150	CN210N0160
Power Supply	Rated Voltage	V~	220-240	220-240
	Rated Frequency	Hz	50	50
	Phases		1	1
Cooling Capacity		W	2500	3500
Heating Capacity		W	2800	3850
Air flow volume(SH/H/M/L/SL)		m ³ /h	-/450/350/280/-	-/550/400/300/-
Dehumidifying Volume		L/h	0.8	1.4
Fan Type			Centrifugal	Centrifugal
Fan Diameter-height		mm	Φ139.45-134.62	Φ139.45-134.62
Fan Motor Speed		rpm	950/750/650/550	1000/920/780/720
Fan Motor Power Output		W	40	30
Fan Motor Power Input		W	75	65
Motor Full Load Amp(FLA)		A	0.34	0.34
Fan Motor Capacitor		μF	3.0	3.0
Evaporator Material			Inner Groove Copper -Aluminum	Inner Groove Copper -Aluminum
Evaporator Pipe Diameter		mm	Φ7	Φ7
Evaporator Number of Rows-Fin Pitch		mm	2-1.6	3-1.6
Evaporator Length(L)XHeight(H)XWidth(W)		mm	527X209.55X25.4	527X209.55X25.4
Fuse Current		A	3.15	3.15
Sound Pressure Level(SH/H/M/L/SL)		dB (A)	37/34/31/47/41	39/35/32/49/42
Sound Power Level(SH/H/M/L/SL)		dB (A)	47/44/41/57/51	49/45/42/59/52
Dimension of Outline(LXWXH)		mm	700X615X200	700X615X200
Dimension of Carton Box(LXWXH)		mm	890X740X290	890X740X290
Dimension of Package(LXWXH)		mm	893X743X305	893X743X305
Net Weight		kg	21	22
Gross Weight		kg	26	28
Liquid pipe		mm	Φ6	Φ6
Gas Pipe(to indoor unit)		mm	Φ9.52	Φ9.52

The above data is subject to change without notice. Please refer to the nameplate of the unit.

Parameter		Unit	Value	
Model			MV-D18BI	MV-D24BI
Product Code			CN210N0170	CN210N0130
Power Supply	Rated Voltage	V~	220-240	220-240
	Rated Frequency	Hz	50	50
	Phases		1	1
Cooling Capacity		W	5000	7100
Heating Capacity		W	5500	8000
Air flow volume(SH/H/M/L/SL)		m ³ /h	-/700/600/500/-	-/1000/750/550/-
Dehumidifying Volume		L/h	1.8	2.5
Fan Type			Centrifugal	Centrifugal
Fan Diameter-height		mm	Φ139.45-134.62	Φ139.45-134.62
Fan Motor Speed		rpm	1140/955/755/670	1185/1070/910/810
Fan Motor Power Output		W	40	80.00
Fan Motor Power Input		W	80	110.00
Motor Full Load Amp(FLA)		A	0.51	0.64
Fan Motor Capacitor		μF	3.0	3.50
Evaporator Material			Inner Groove Copper -Aluminum	Inner Groove Copper -Aluminum
Evaporator Pipe Diameter		mm	Φ7	Φ7
Evaporator Number of Rows-Fin Pitch		mm	3-1.6	3-1.6
Evaporator Length(L)XHeight(H)XWidth(W)		mm	725X209.55X38.1	925X209.55X38.1
Fuse Current		A	3.15	3.15
Sound Pressure Level(SH/H/M/L/SL)		dB (A)	41/33/51/43/-	42/34/52/44/-
Sound Power Level(SH/H/M/L/SL)		dB (A)	51/43/61/53/-	52/44/62/55/-
Dimension of Outline(LXWXH)		mm	900X615X200	1100X615X200
Dimension of Carton Box(LXWXH)		mm	1120X740X290	1320X740X290
Dimension of Package(LXWXH)		mm	1123X743X305	1323X743X305
Net Weight		kg	26	30
Gross Weight		kg	32	40
Liquid pipe		mm	Φ6	Φ9.52
Gas Pipe(to indoor unit)		mm	Φ12	Φ16

The above data is subject to change without notice. Please refer to the nameplate of the unit.

Notes:

a. The rated cooling capacity data is measured under the following work condition: Indoor Temperature is 27°C DB, 19°C WB. Outdoor Temperature is 35°CDB. The rated heating capacity data is measured under the following work condition: Indoor Temperature is 20°CDB. Outdoor Temperature is 7°CDB, 6°CWB.

b. The data will change with the change of products. Refer to those parameters listed on nameplate.

c. Noise was tested in semi-silenced room, so the actual noise value will be a little higher for change of ambient.

Working Temperature Range

Sorts	Indoor side state	
	Dry bulb temp. °C	Wet bulb temp. °C
Rated Cooling	27	19
Max. cooling	32	23
Min. cooling	21	15
Rated Heating	20	15
Max. heating	27	—
Min. heating	20	15

3. Outline Dimension Diagram

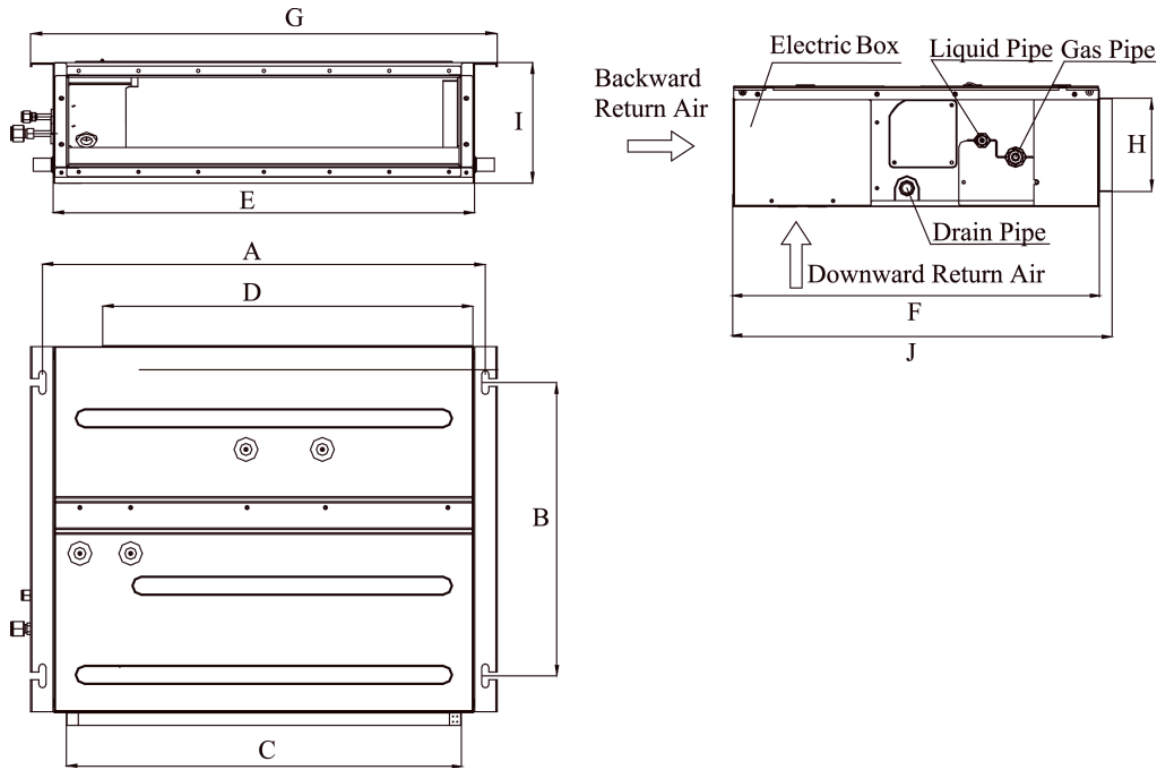

Unit:mm

Model \ Item	A	B	C	D	E	F	G	H	I	J
MV-D09BI	742	491	662	620	700	615	782	156	200	635
MV-D12BI										
MV-D18BI	942	491	862	820	900	615	982	156	200	635
MV-D24BI	1142	491	1062	1020	1100	615	1182	156	200	635

4. Refrigerant System Diagram

Schematic Diagram of Super Free Match Series Inverter Heat Pump Multi System

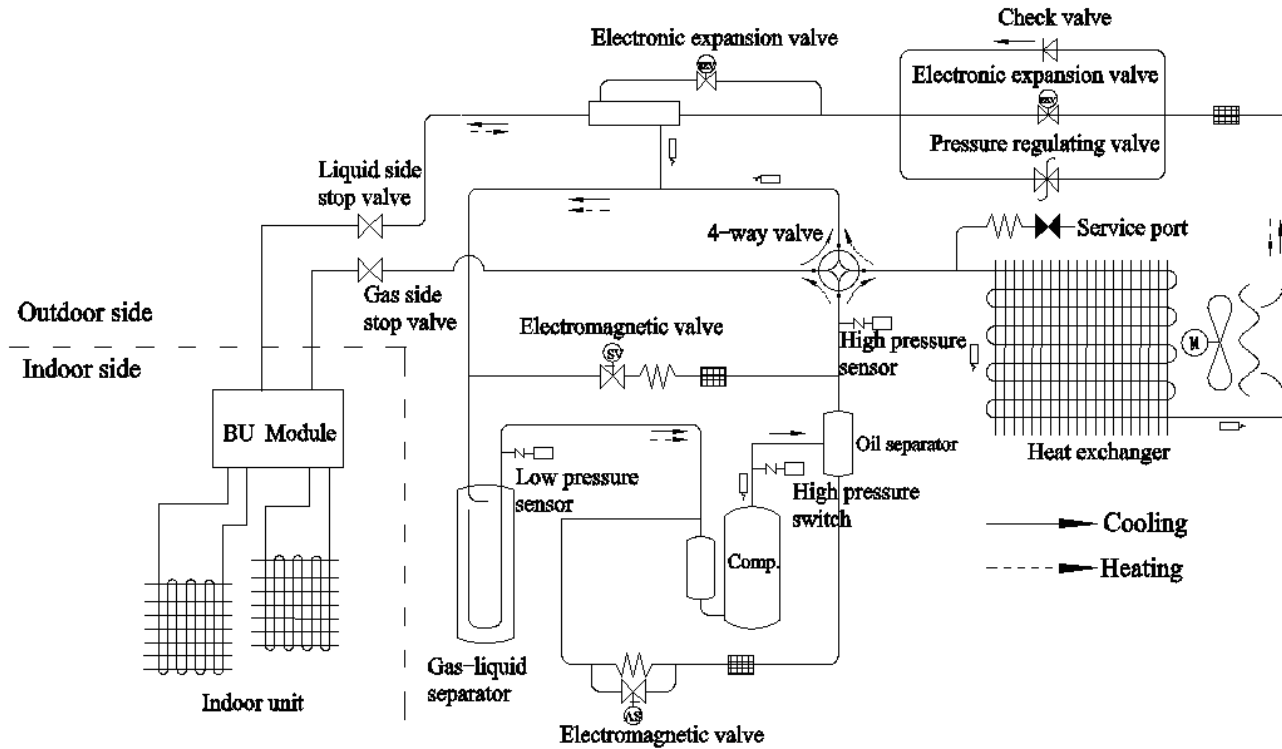

The units start to work once the power is switched on.

During the cooling operation, the low temperature, low pressure refrigerant gas from the heat exchanger of each indoor unit gets together and then is taken into the compressor to be compressed into high temperature, high pressure gas, which will soon go to the heat exchanger of the outdoor unit to exchange heat with the outdoor air and then is turned into refrigerant liquid. After passing through the BU module, the temperature and pressure of the refrigerant liquid will further decrease and then go the main valve. After that, it will be divided and go to the heat exchanger of each indoor unit to exchange heat with the air which needs to be conditioned. Consequently, the refrigerant liquid become low temperature, low pressure refrigerant gas again. Such a refrigeration cycle goes round and round to achieve the desired refrigeration purpose.

During the heating operation, the four-way valve is involved to make the refrigeration cycle run reversely. The refrigerant radiates heat in the heat exchanger of the indoor unit (so do the electric heating devices) and absorb heat in the heat exchanger of the outdoor unit for a heat pump heating cycle so as to achieve the desired heating purpose.

5. Electrical Part

5.1 Wiring Diagram

• Instruction

Symbol	Symbol Color	Symbol	Symbol Color	Symbol	Name
WH	White	GN	Green	CAP	Jumper cap
YE	Yellow	BN	Brown	COMP	Compressor
RD	Red	BU	Blue		Grounding wire
YEGN	Yellow/Green	BK	Black	/	/
VT	Violet	OG	Orange	/	/

Note: Jumper cap is used to determine fan speed and the swing angle of horizontal lover for this model.

• Indoor Unit

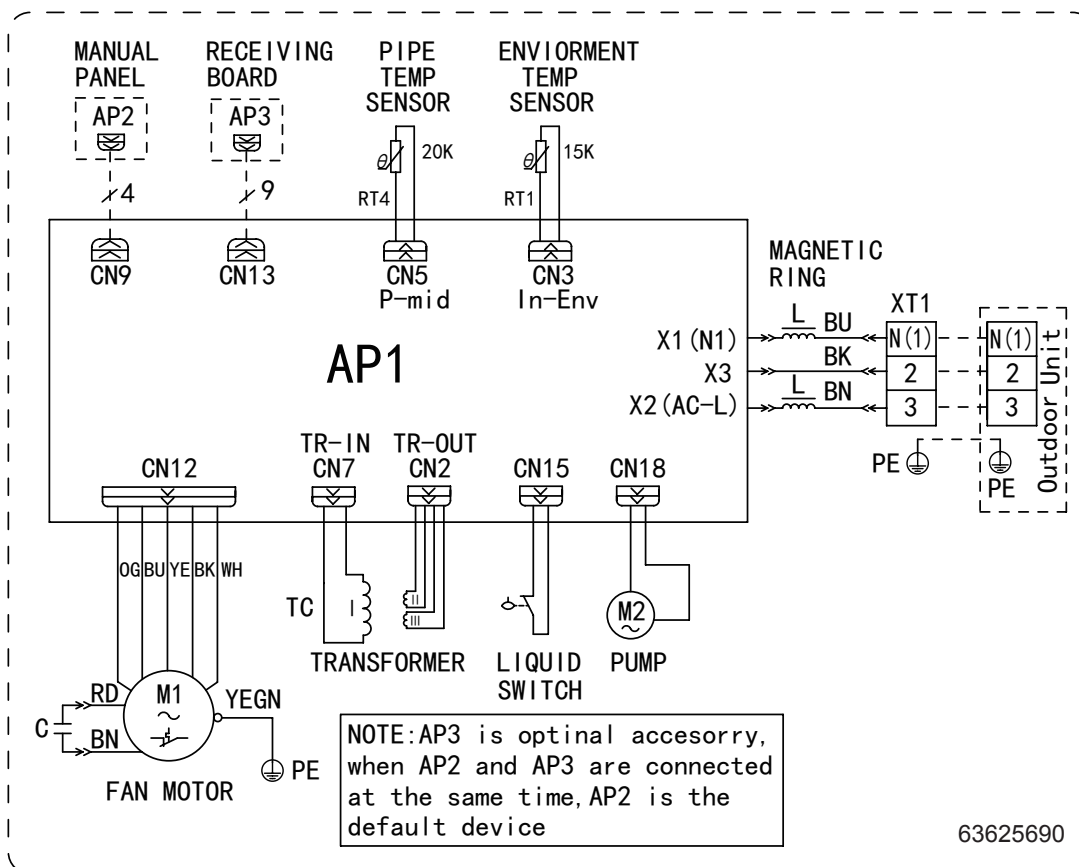

These circuit diagrams are subject to change without notice, please refer to the one supplied with the unit.

5.2 PCB Printed Diagram

• Top view

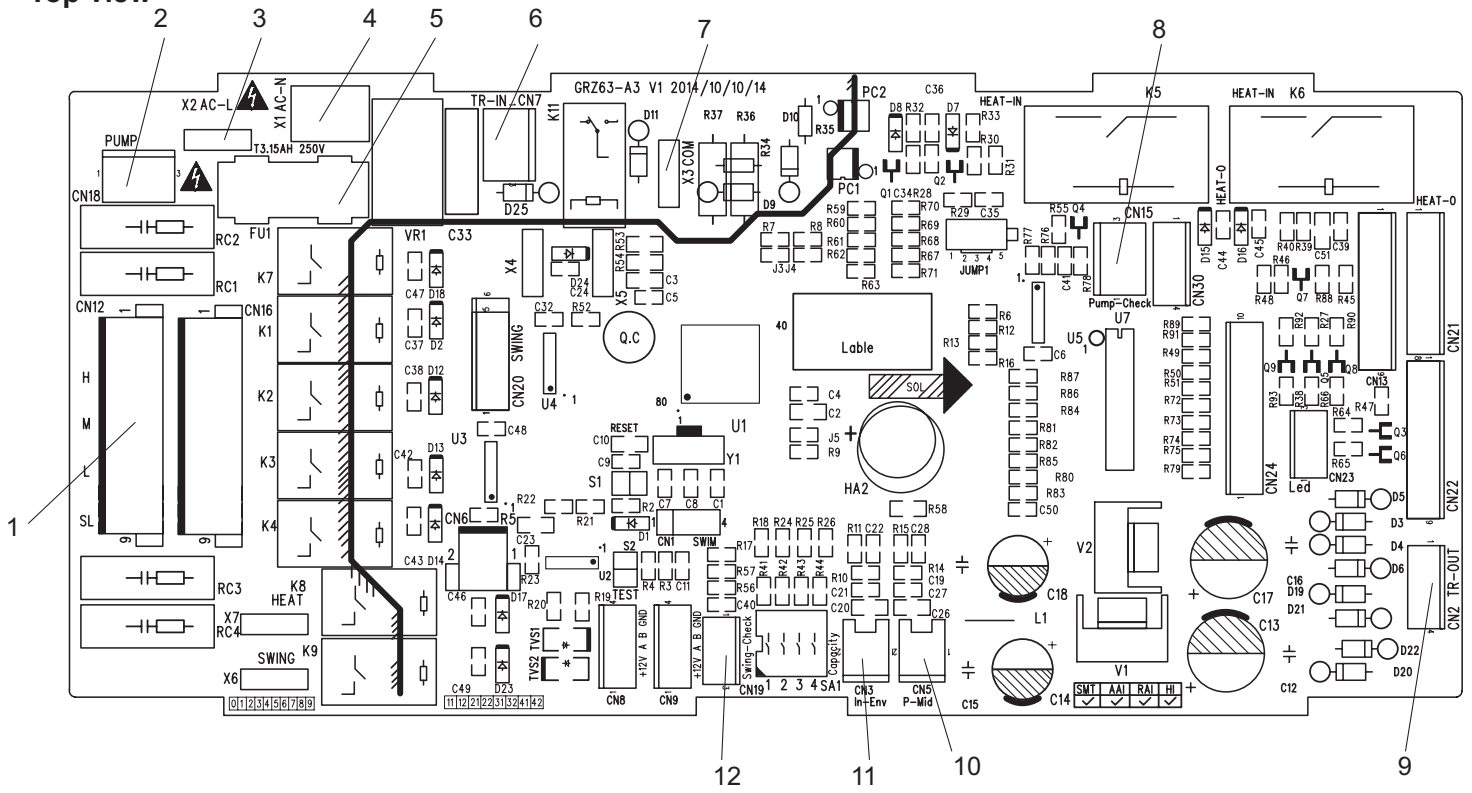

• Bottom view

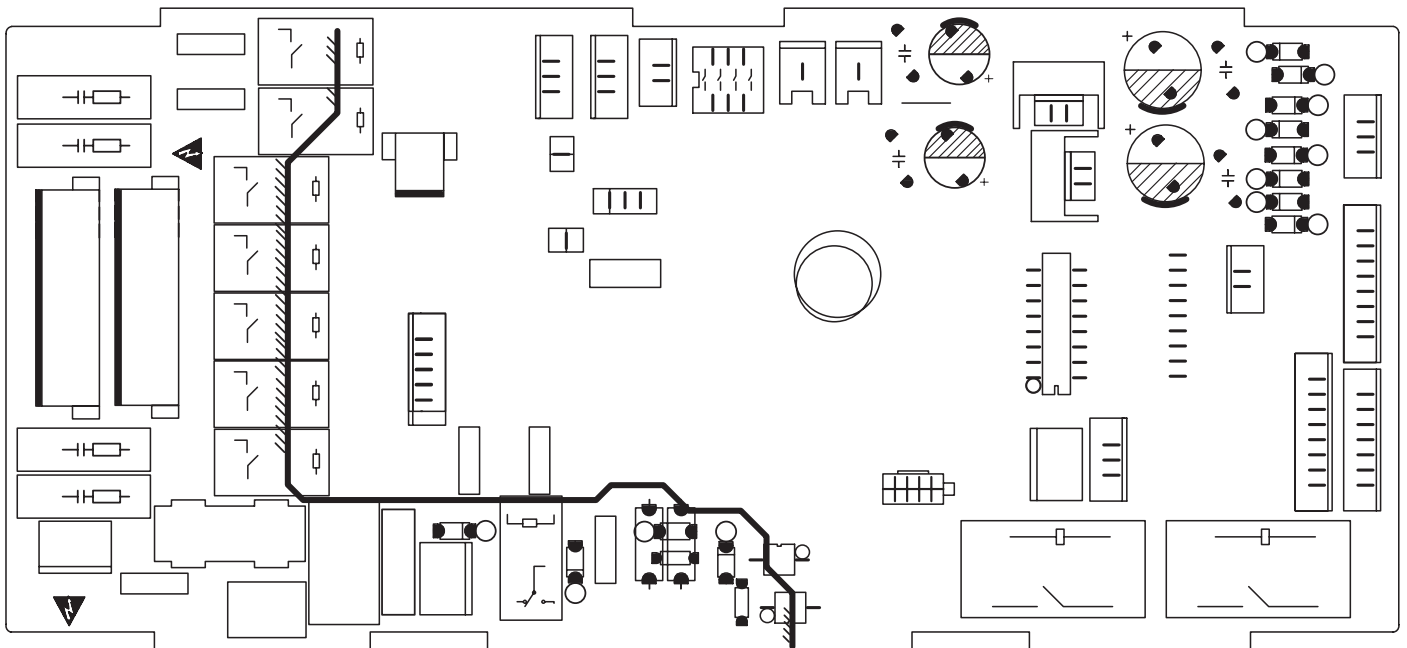

No.	Name		
1	Fan terminal	7	Communication terminal for indoor unit and outdoor unit
2	Water pump terminal	8	Liquid level switch inspection
3	Live wire	9	Output terminal of transformer
4	Neutral wire	10	Ambient temperature sensor
5	Fuse	11	Tube temperature sensor
6	Transformer input	12	Wired controller

6. Function and Control

6.1 Remote Controller Introduction

Buttons on Remote Controller

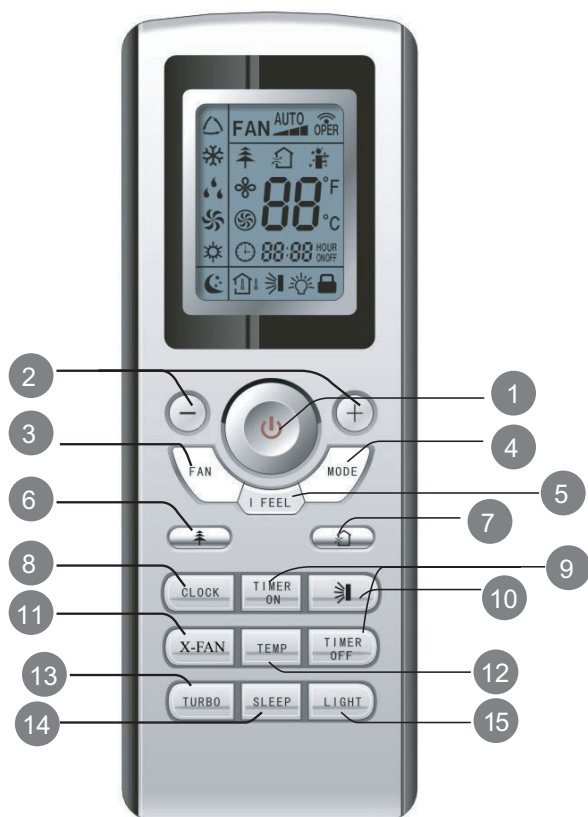

- 1 ON/OFF button
- 2 +/- button
- 3 FAN button
- 4 MODE button
- 5 I FEEL button
- 6 button
- 7 button
- 8 CLOCK button
- 9 TIMER ON/TIMER OFF button
- 10 button
- 11 X-FAN button
(Note:X-FAN is the same with BLOW)
- 12 TEMP button
- 13 TURBO button
- 14 SLEEP button
- 15 LIGHT button

Introduction for Icons on Display Screen

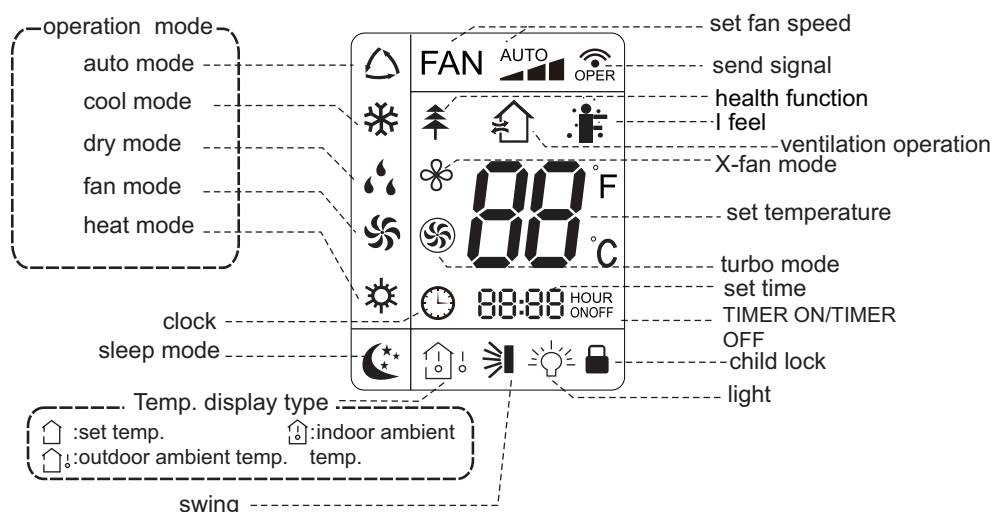

Introduction for Buttons on Remote Controller

Note:

This is a general use remote controller, it could be used for the air conditioners with multifunction; For some function, which the model don't have, if press the corresponding button on the remote controller that the unit will keep the original running status.

After putting through the power, the air conditioner will give out a sound. Operation indicator "⏻" is ON (red indicator). After that, you can operate the air conditioner by using remote controller.



1. ON/OFF button

Pressing this button can turn on or turn off the air conditioner. After turning on the air conditioner, operation indicator "⏻" on indoor unit's display is ON (green indicator. The colour is different for different models), and indoor unit will give out a sound.

2. "+" or "-" button

- Press "+" or "-" button once increase or decrease set temperature 1°C. Holding "+" or "-" button, 2s later, set temperature on remote controller will change quickly. On releasing button after setting is finished, temperature indicator on indoor unit will change accordingly. (Temperature can't be adjusted under auto mode)
- When setting TIMER ON, TIMER OFF or CLOCK, press "+" or "-" button to adjust time. (Refer to CLOCK, TIMER ON, TIMER OFF buttons) When setting TIMER ON, TIMER OFF or CLOCK, press "+" or "-" button to adjust time. (Refer to CLOCK, TIMER ON, TIMER OFF buttons)









3. FAN button

Pressing this button can set fan speed circularly as: auto (AUTO), low() ,medium() ,high() .

4. MODE button

Press this button to select your required operation mode.



- When selecting auto mode, air conditioner will operate automatically according to exfactory setting. Set temperature can't be adjusted and will not be displayed as well. Press "FAN" button can adjust fan speed. Press "  " button can adjust fan blowing angle.
- After selecting cool mode, air conditioner will operate under cool mode. Cool indicator "  " on indoor unit is ON. Press "+" or "-" button to adjust set temperature. Press "FAN" button to adjust fan speed. Press "  " button to adjust fan blowing angle.
- When selecting dry mode, the air conditioner operates at low speed under dry mode. Dry indicator "  " on indoor unit is ON. Under dry mode, fan speed can't be adjusted. Press "  " button to adjust fan blowing angle.
- When selecting fan mode, the air conditioner will only blow fan, no cooling and no heating. all indicators are OFF. Press "FAN" button to adjust fan speed. Press "  " button to adjust fan blowing angle.
- When selecting heating mode, the air conditioner operates under heat mode. Heat indicator "  " on indoor unit is ON. Press "+" or "-" button to adjust set temperature, Press "FAN" button to adjust fan speed. Press "  " button to adjust fan blowing angle. (Cooling only unit won't receive heating mode signal. If setting heat mode with remote controller, press ON/OFF button can't start up the unit).

Note:

- For preventing cold air, after starting up heating mode, indoor unit will delay 1~5 minutes to blow air (actual delay time is depend on indoor ambient temperature).
- Set temperature range from remote controller: 16~30°C ; Fan speed: auto, low speed, medium speed, high speed.

5. I FEEL button

Press this button to turn on I FEEL function. The unit automatically adjust temperature according to the sensed temperature. Press this button again to cancel I FEEL function.



6. button

Press this button to set HEALTH function ON or OFF. After the unit is turned on, it defaults to HEALTH function ON.

7. button (Only available for some models)

Press this button to select AIR function ON or OFF.

8. CLOCK button



Press this button to set clock time. "  " icon on remote controller will blink. Press "+" or "-" button within 5s to set clock time. Each pressing of "+" or "-" button, clock time will increase or decrease 1 minute. If hold "+" or "-" button, 2s later, time will change quickly. Release this button when reaching your required time. Press "CLOCK" button to confirm the time. "  " icon stops blinking.

Note:



- Clock time adopts 24-hour mode.
- The interval between two operation can't exceeds 5s. Otherwise, remote controller will quit setting status. Operation for TIMER ON/ TIMER OFF is the same.

9. TIMER ON/TIMER OFF button

● TIMER ON button

"TIMER ON" button can set the time for timer on. After pressing this button, "  " icon disappears and the word "ON" on remote controller blinks. Press "+" or "-" button to adjust TIMER ON setting. After each pressing "+" or "-" button, TIMER ON setting will increase or decrease 1min. Hold "+" or "-" button, 2s later, the time will change quickly until reaching your required time. Press "TIMER ON" to confirm it. The word "ON" will stop blinking. "  " icon resumes displaying. Cancel TIMER ON: Under the condition that TIMER ON is started up, press "TIMER ON" button to cancel it.

● TIMER OFF button

"TIMER OFF" button can set the time for timer off. After pressing this button, "  " icon disappears and the word "OFF" on remote controller blinks. Press "+" or "-" button to adjust TIMER OFF setting. After each pressing "+" or "-" button, TIMER OFF setting will increase or decrease 1min. Hold "+" or "-" button, 2s later, the time will change quickly until reaching your required time. Press "TIMER OFF" word "OFF" will stop blinking. "  " icon resumes displaying. Cancel TIMER OFF. Under the condition that TIMER OFF is started up, press "TIMER OFF" button to cancel it.

Note:









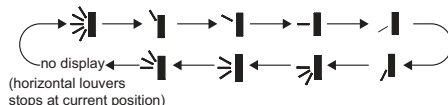

- Under on and off status, you can set TIMER OFF or TIMER on simultaneously.
- Before setting TIMER ON or TIMER OFF, please adjust the clock time.

- After starting up TIMER ON or TIMER OFF, set the constant circulating valid. After that, air conditioner will be turned on or turned off according to setting time. ON/OFF button has no effect on setting. If you don't need this function, please use remote controller to cancel it.

10. button

Press this button can select up&down swing angle. Fan blow angle can be selected circularly as below:





- When selecting "", air conditioner is blowing fan automatically. Horizontal louver will automatically swing up & down at maximum angle.
- When selecting ", , , , ", air conditioner is blowing fan at fixed position. Horizontal louver will stop at the fixed position.
- When selecting ", , , ", air conditioner is blowing fan at fixed angle. Horizontal louver will send air at the fixed angle.
- Hold "" button above 2s to set your required swing angle. When reaching your required angle, release the button.

Note:

", , , " may not be available. When air conditioner receives this signal, the air conditioner will blow fan automatically.



11. X-FAN button

Press this button under cool and dry mode to start up x-fan function, and "" icon on remote controller will be displayed. Press this button again to cancel x-fan function, and "" icon will disappear.

12. TEMP button

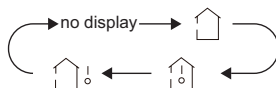
By pressing this button, you can see indoor set temperature, indoor ambient temperature or outdoor ambient temperature on indoor unit's display. The setting on remote controller is selected circularly as below:



When selecting "" or no display with remote controller, temperature indicator on indoor unit displays set temperature;
 When selecting "" with remote controller, temperature indicator on indoor unit displays indoor ambient temperature;
 When selecting "" with remote controller, temperature indicator on indoor unit displays outdoor ambient temperature.



Note:

- Outdoor temperature display is not available for some models. At that time, indoor unit receives "" signal, while it displays indoor set temperature.
- It's defaulted to display set temperature when turning on the unit. There is no display in the remote controller.
- Only for the models whose indoor unit has dual-8 display



13. TURBO button

Under COOL or HEAT mode, press this button to turn to quick COOL or quick HEAT mode. "" icon is displayed on remote controller. Press this button again to exit turbo function and "" icon will disappear.

14. SLEEP button

Under COOL, HEAT mode, press this button to start up sleep function. "" icon is displayed on remote controller. Press this button again to cancel sleep function and "" icon will disappear.

15. LIGHT button

Pressing this button to turn off display light on indoor unit. "" icon on remote controller disappears. Press this button again to turn on display light. "" icon is displayed.

Function Introduction for Combination Buttons

Child lock function:

Press "+" and "-" simultaneously to turn on or turn off child lock function. When child lock function is on, "" icon is displayed on remote controller. If you operate the remote controller, it won't send signal.

Temperature display switchover function:

Under OFF status, press "-" and "MODE" buttons simultaneously to switch temperature display between °C and °F.

Operation Guide

1. After putting through the power, press "ON/OFF" button on remote controller to turn on the air conditioner.
2. Press "MODE" button to select your required mode: AUTO, COOL, DRY, FAN, HEAT.
3. Press "+" or "-" button to set your required temperature. (Temperature can't be adjusted under auto mode).
4. Press "FAN" button to set your required fan speed: auto, low, medium and high speed.
5. Press "" button to select fan blowing angle.

Replacement of Batteries in Remote Controller

1. Press the back side of remote controller marked with "OPEN" as shown in the fig, and then push out the cover of battery box along the arrow direction.
2. Replace two 7# (AAA 1.5V) dry batteries, and make sure the position of "+" polar and "-" polar are correct.
3. Reinstall the cover of battery box.

Note:

- During operation, point the remote control signal sender at the receiving window on indoor unit.
- The distance between signal sender and receiving window should be no more than 8m, and there should be no obstacles between them.
- Signal may be interfered easily in the room where there is fluorescent lamp or wireless telephone; remote controller should be close to indoor unit during operation.
- Replace new batteries of the same model when replacement is required.
- When you don't use remote controller for a long time, please take out the batteries.
- If the display on remote controller is fuzzy or there's no display, please replace batteries.

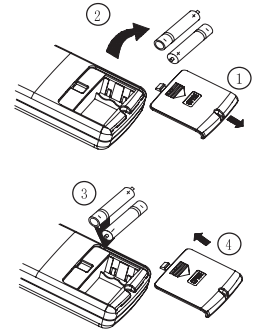

Sketch map for replacing batteries

6.2 Brief Description of Modes and Functions

1. Basic function of system

(1) Cooling mode

- (1) Under this mode, fan and swing operates at setting status. Temperature setting range is 16~30°C.
- (2) During malfunction of outdoor unit or the unit is stopped because of protection, indoor unit keeps original operation status.

(2) Drying mode

- (1) Under this mode, fan operates at low speed and swing operates at setting status. Temperature setting range is 16~30°C.
- (2) During malfunction of outdoor unit or the unit is stopped because of protection, indoor unit keeps original operation status.
- (3) Protection status is same as that under cooling mode.
- (4) Sleep function is not available for drying mode.

(3) Heating mode

- (1) Under this mode, Temperature setting range is 16~30°C.
- (2) Working condition and process for heating mode:

When turn on the unit under heating mode, indoor unit enters into cold air prevention status. When the unit is stopped or at OFF status, and indoor unit has been started up just now, the unit enters into residual heat-blowing status.

(4) Working method for AUTO mode:

1. Working condition and process for AUTO mode:
 - a. Under AUTO mode, standard heating $T_{\text{preset}}=20^{\circ}\text{C}$ and standard cooling $T_{\text{preset}}=25^{\circ}\text{C}$. The unit will switch mode automatically according to ambient temperature.
2. Protection function
 - a. During cooling operation, protection function is same as that under cooling mode.
 - b. During heating operation, protection function is same as that under heating mode.
3. Display: Set temperature is the set value under each condition. Ambient temperature is ($T_{\text{amb.}}-T_{\text{compensation}}$) for heat pump unit and $T_{\text{amb.}}$ for cooling only unit.
4. If theres I feel function, $T_{\text{compensation}}$ is 0. Others are same as above.

(5) Fan mode

Under this mode, indoor fan operates at set fan speed. Compressor, outdoor fan, 4-way valve and electric heating tube stop operation. Indoor fan can select to operate at high, medium, low or auto fan speed. Temperature setting range is 16~30°C.

2. Other control

(1) Buzzer

Upon energization or availably operating the unit or remote controller, the buzzer will give out a beep.

(2) Auto fan

Heating mode: During auto heating mode or normal heating ode, auto fan speed will adjust the fan speed automatically according to ambient temperature and set temperature.

(3) Sleep

After setting sleep function for a period of time, system will adjust set temperature automatically.

(4) Timer function:

General timer and clock timer functions are compatible by equipping remote controller with different functions.

(5) Memory function

memorize compensation temperature, off-peak energization value.

Memory content: mode, up&down swing, light, set temperature, set fan speed, general timer (clock timer cant be memorized).

After power recovery, the unit will be turned on automatically according to memory content.

(6) Refrigerant recovery function:

- (1) Enter refrigerant recycling function

Within 5min after energizing (unit ON or OFF status is ok), continuously press LIGHT button for 3 times within 3s to enter refrigerant recycling mode; Fo is displayed and refrigerant recycling function is started. At this moment, the maintenance people closes liquid valve. After 5min, stick the thimble of maintenance valve with a tool. If there is no refrigerant spraying out, close the gas valve immediately and then turn off the unit to remove the connection pipe.

(2) Exit refrigerant recycling function

After entering refrigerant recycling mode, when receive any remote control signal or enter refrigerant recycling mode for 25min, the unit will exit refrigerant recycling mode automatically. If the unit is in standby mode before refrigerant recycling, it will be still in standby mode after finishing refrigerant recycling; if the unit is in ON status before refrigerant recycling, it will still run in original operation mode.

(7) Off-peak energization function:

Adjust compressors minimum stop time. The original minimum stop time is 180s and then we change to:

The time interval between two start-ups of compressor can't be less than $180+T$ s ($0 \leq T \leq 15$). T is the variable of controller. That's to say the minimum stop time of compressor is 180s~195s. Read-in T into memory chip when refurbish the memory chip each time. After power recovery, compressor can only be started up after $180+T$ s at least.

(8) X-fan mode

When X-fan function is turned on, after turn off the unit, indoor fan will still operate at low speed for 2min and then the complete unit will be turned off. When x-fan function is turned off, after turn off the unit, the complete unit will be turned off directly.

(9) 8° heating function

Under heating mode, you can set 8° heating function by remote controller. The system will operate at 8° set temperature.

(10) Turbo fan control function

Set turbo function under cooling or heating mode to enter into turbo fan speed. Press fan speed button to cancel turbo wind.

No turbo function under auto, dry or fan mode.

6.3 Wired Remote Controller XK19

1.1 Outside View of the Wired Remote Controller



Fig.1 Outside View of the Wired Remote Controller

1.2 LCD of the Wired Remote Controller

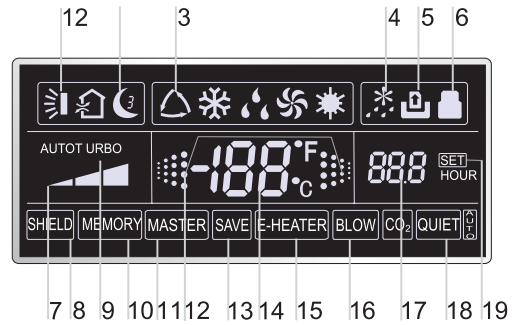

Fig.2 LCD of the Wired Remote Controller

Table 1

No.	Symbols	Description
1		Swing function.
2		Sleep function (Only sleep 1).
3		Running modes of the indoor unit (Cooling, Dry, Fan and Heating).
4		Defrosting function for the outdoor unit.
5		Gate-control function (this function is yet unavailable for this unit).
6		Lock function.
7		High, middle, low or auto fan speed of the indoor unit.
8		Shield functions (buttons, temperature, On/Off or Mode is shielded by the remote monitor).
9		Turbo function.
10		Memory function (The indoor unit resumes the original setting state after power failure and then power recovery).
11		Master wired remote controller (this function is yet unavailable for this unit).
12		It blinks under on state of the unit without operation of any button.
13		Energy-saving function (this function is yet unavailable for this unit).
14		Ambient/preset temperature value.
15		Electric auxiliary heating function.
16		Blow function.
17		Timing value.
18		Quiet function (two types: quiet and auto quiet) (this function is yet unavailable for this unit).
19	SET	It will be displayed under the debugging mode.

2 Buttons

2.1 Buttons on the Wired Remote Controller

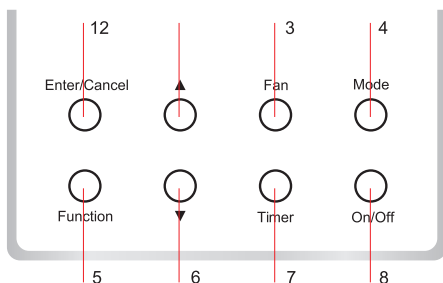



Fig. 3 Buttons on the Wired Remote Controller

2.2 Function of the Buttons

Table 2

No.	Name	Function
1	Enter/Cancel	Function selection and cancellation.
2	▲	① Running temperature setting of the indoor unit, range:16 ~ 30℃ . ② Timer setting, range:0.5-24 hr.
6	▼	
3	Fan	Setting of the high/middle/low/auto fan speed.
4	Mode	Setting of the Cooling/Heating/Fan/Dry/Auto mode of the indoor unit.
5	Function	Switchover among the functions of Turbo/Save/E-heater/Blow etc..
7	Timer	Timer setting.
8	On/Off	Turn on/off the indoor unit.
4+2	▲+Mode	Press them for 5s under off state of the unit to Enter/Cancel the Memory function(If memory is set, indoor unit after power failure and then power recovery will resume the original setting state. If not, the indoor unit is defaulted to be off after power recovery. Memory off is default before delivery.).
3+6	Fan+▼	By pressing them at the same time under off state of the unit,  will be displayed on the wired remote controller for the cooling only unit, while  will be displayed on the wired remote controller for the cooling and heating unit .
2+6	▲+▼	Upon startup of the unit without malfunction or under off state of the unit,press them at the same time for 5s to enter the lock state, in which case, any other buttons won't respond the press. Re-press them for 5s to quit this state.
4+6	Mode+▼	Under OFF state, the Celsius and Fahrenheit scales can be switched by pressing "Mode" and "▼" for five seconds.
5+7	Function+Timer	Under OFF state, it is available to go to the commissioning status by pressing "Function" and "Timer" for five seconds, and let "00" displayed on the temperature display area by pressing "Mode", then adjust the options which is shown on the timer area by pressing "▲" and "▼". There are totally four options, as follows: ① Indoor ambient temperature is sensed by the return air temperature sensor (01 displayed on the timer area). ② Indoor ambient temperature is sensed by the wired controller (02 displayed on the timer area). ③ The return air temperature sensor is selected under the cooling, dry, or fan mode; while the wired controller temperature sensor is selected under the heating or auto mode. (03 is displayed on the timer area). ④ The wired controller temperature sensor is selected under the cooling, dry, or fan mode; while the return air temperature sensor is selected under the heating mode. (04 is displayed on the timer display area).
5+7	Function+Timer	Under OFF state, it is available to go to the commissioning status by pressing "Function" and "Timer" for five seconds. Press "Mode" button to until "01" icon is shown at the temperature display area. The setting status will be shown at timer area. Press "▲" and "▼" button to adjust and two options are available: ① Three low levels (01) ; ② Three high levels (02).

3 Operation Instructions

3.1 On/Off

Press On/Off to turn on the unit and turn it off by another press.

Note: The state shown in Fig.4 indicates the "Off" state of the unit after power on. The state shown in Fig.5 indicates the "On" state of the unit after power on.

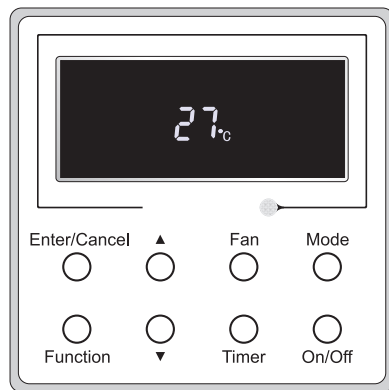

Fig. 4 "Off" State

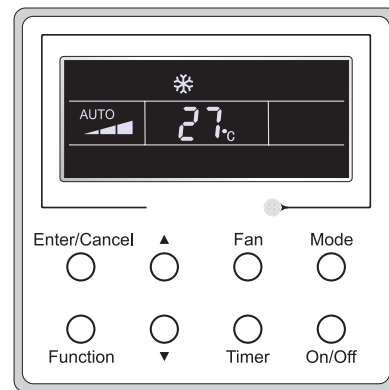
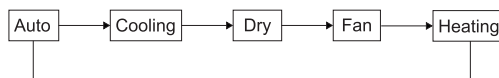

Fig. 5 "On" State

3.2 Mode Setting

Under the "On" state of the unit, press Mode to switch the operation modes as the following sequence:Auto-Cooling-Dry-Fan-Heating.



3.2 Mode Setting

Under the "On" state of the unit, press Mode to switch the operation modes as the following sequence:Auto-Cooling-Dry-Fan-Heating.

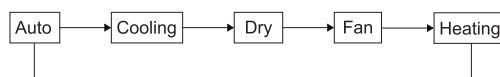

3.3 Temperature Setting

Press ▲ or ▼ to increase/decrease the preset temperature. If press either of them continuously, the temperature will be increased or decreased by 1℃ every 0.5s as shown in Fig.6. In the Cooling, Dry, Fan or Heating mode, the temperature setting range is 16℃~ 30℃ . In the Auto mode, the setting temperature is unadjustable.

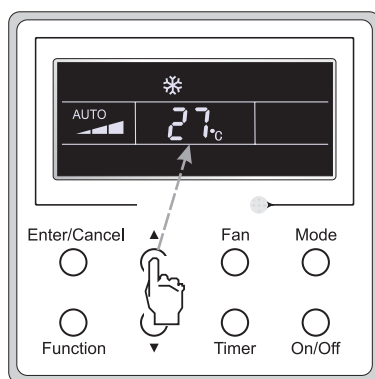

Fig.6

3.4 Fan Setting

Under the “On”/“Off” state of the unit, press Fan and then fan speed of the indoor unit will change circularly as shown in Fig.7.

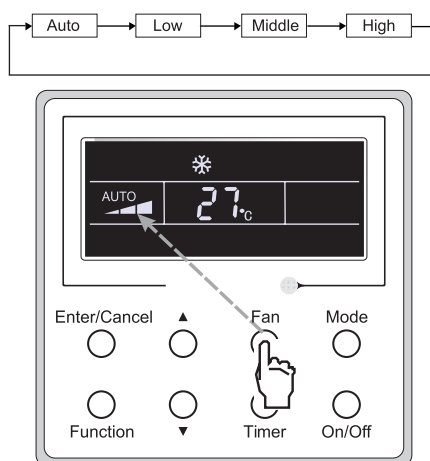

Fig.7

3.5 Timer Setting

Under the “On”/“Off” state of the unit, press Timer to set timer off/on. Timer on setting: press Timer, and then LCD will display “xx.x hour”, with “hour” blinking. In this case, press ▲ or ▼ to adjust the timing value. Then press Enter/Cancel to confirm the setting. Timer off setting: press Timer, if LCD won't display xx.x hour, and then it means the timer setting is canceled.

Timer off setting under the “On” state of the unit is shown as Fig.8.

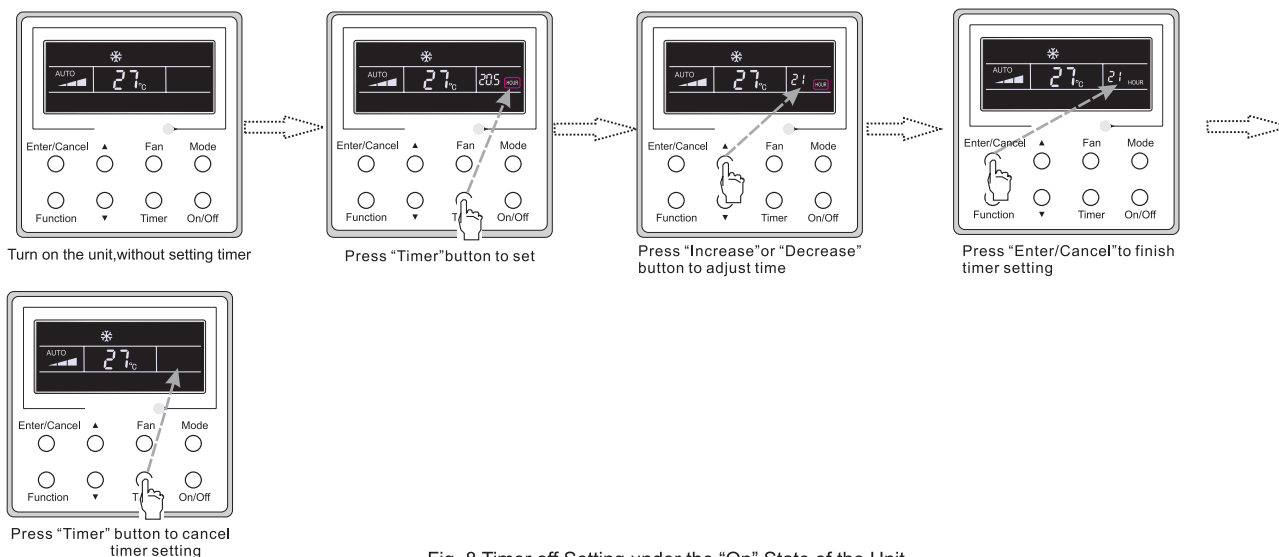



Fig. 8 Timer off Setting under the “On” State of the Unit

Timer range: 0.5-24hr. Every press of ▲ or ▼ will make the set time increased or decreased by 0.5hr. If either of them is pressed continuously, the set time will increase/ decrease by 0.5hr every 0.5s.

3.6 Swing Setting

Swing On: Press Function under on state of the unit to activate the swing function. In this case,  will blink. After that, press Enter/Cancel to make a confirmation.

Swing Off: When the Swing function is on, press Function to enter the Swing setting interface, with  blinking. After that, press Enter/Cancel to cancel this function.

Swing setting is shown as Fig.9.

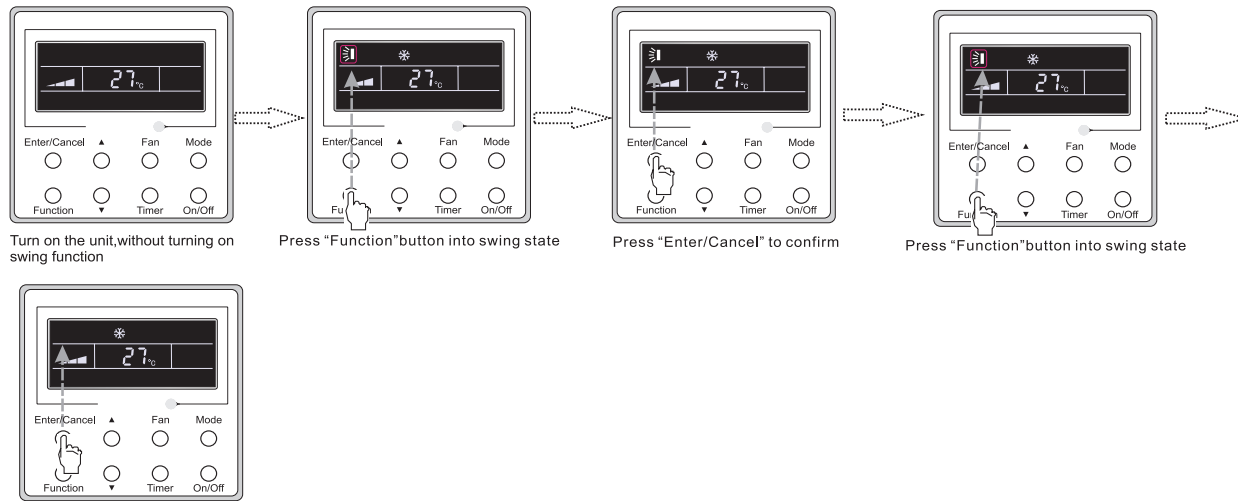

Fig. 9 Swing Setting

Note:

- ① . Sleep, Turbo or Blow setting is the same as the Swing setting.
- ② . After the setting has been done, it has to press the key "Enter/Cancel" to back to the setting status or quit automatically five seconds later.

3.7 Sleep Setting

Sleep on: Press Function under on state of the unit till the unit enters the Sleep setting interface. Press Enter/Cancel to confirm the setting.

Sleep off: When the Sleep function is activated, press Function to enter the Sleep setting interface. After that, press Enter/Cancel to can this function.

In the Cooling or Dry mode, the temperature will increase by 1°C after the unit runs under Sleep 1 for 1hr and 1°C after another 1hr. After that, the unit will run at this temperature. In the Heating mode, the temperature will decrease by 1°C after the unit runs under Sleep 1 for 1hr and 1°C after another 1hr. After that, the unit will run at this temperature.

Sleep setting is shown as Fig.10.

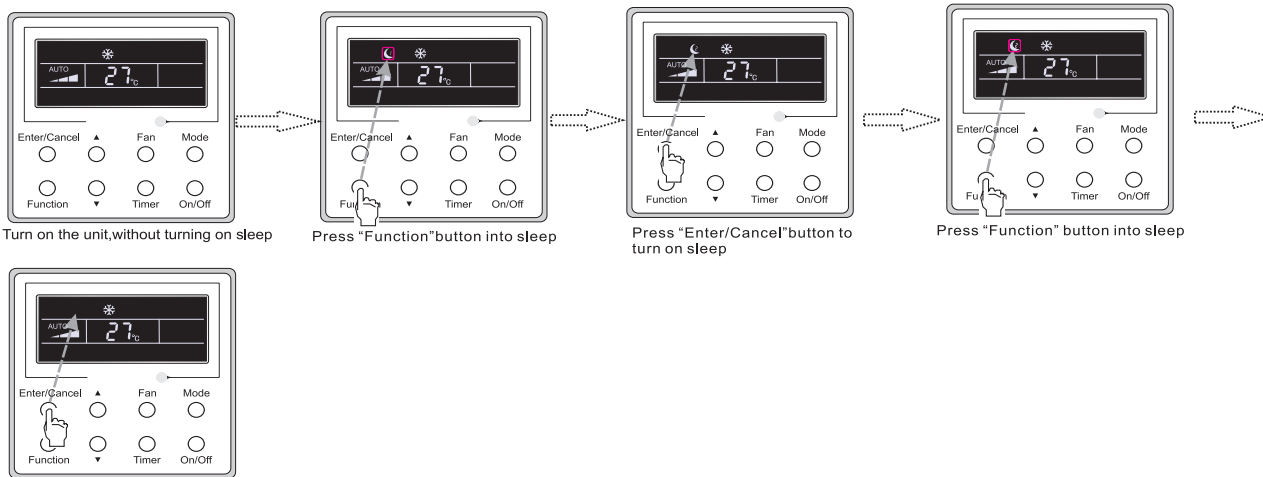

Fig. 10 Sleep Setting

3.8 Turbo Setting

Turbo function: The unit at the high fan speed can realize quick cooling or heating so that the room temperature can quickly approach the setting value.

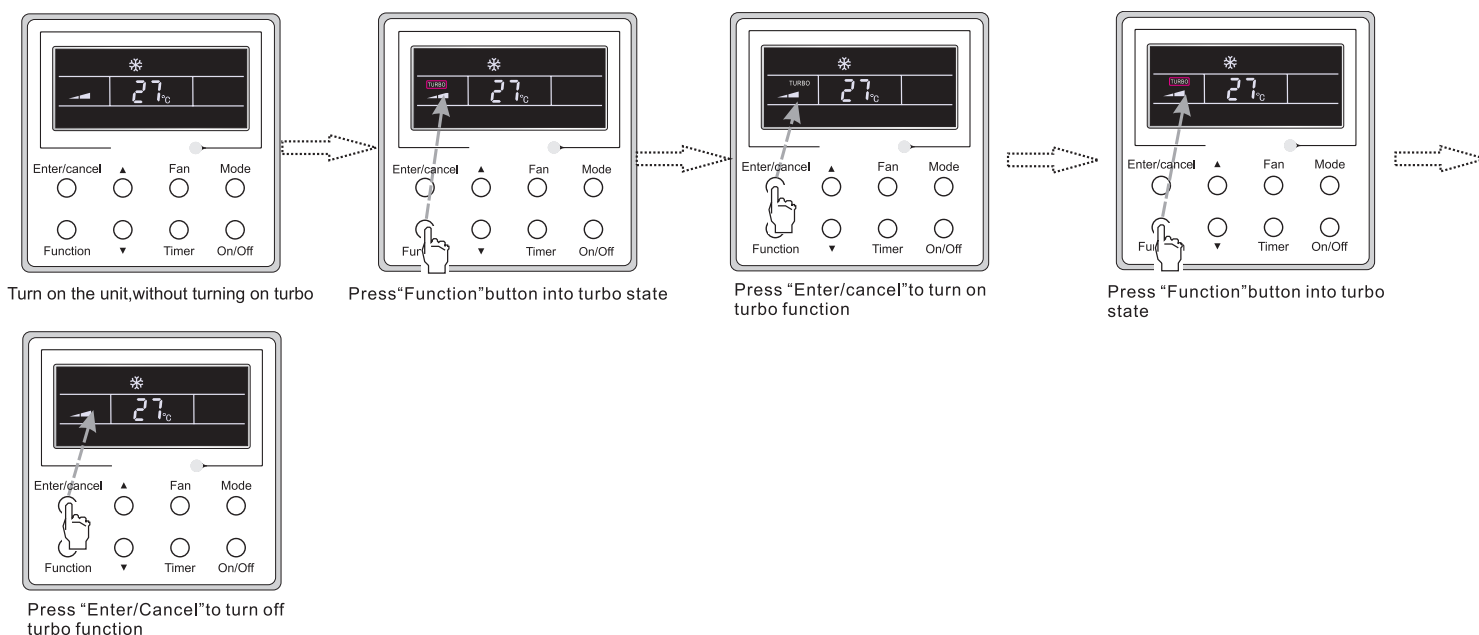

Fig.11 Turbo Setting

3.9 E-heater Setting

E-heater (auxiliary electric heating function): In the Heating mode, E-heater is allowed to be turned on for improvement of efficiency.

Once the wired remote controller or the remote controller enters the Heating mode, this function will be turned on automatically.

Press Function in the Heating mode to enter the E-heater setting interface and then press Enter/Cancel to cancel this function.

Press Function to enter the E-heater setting interface, if the E-heater function is not activated, and then press Enter/Cancel to turn it on.

The setting of this function is shown as Fig.12 below:

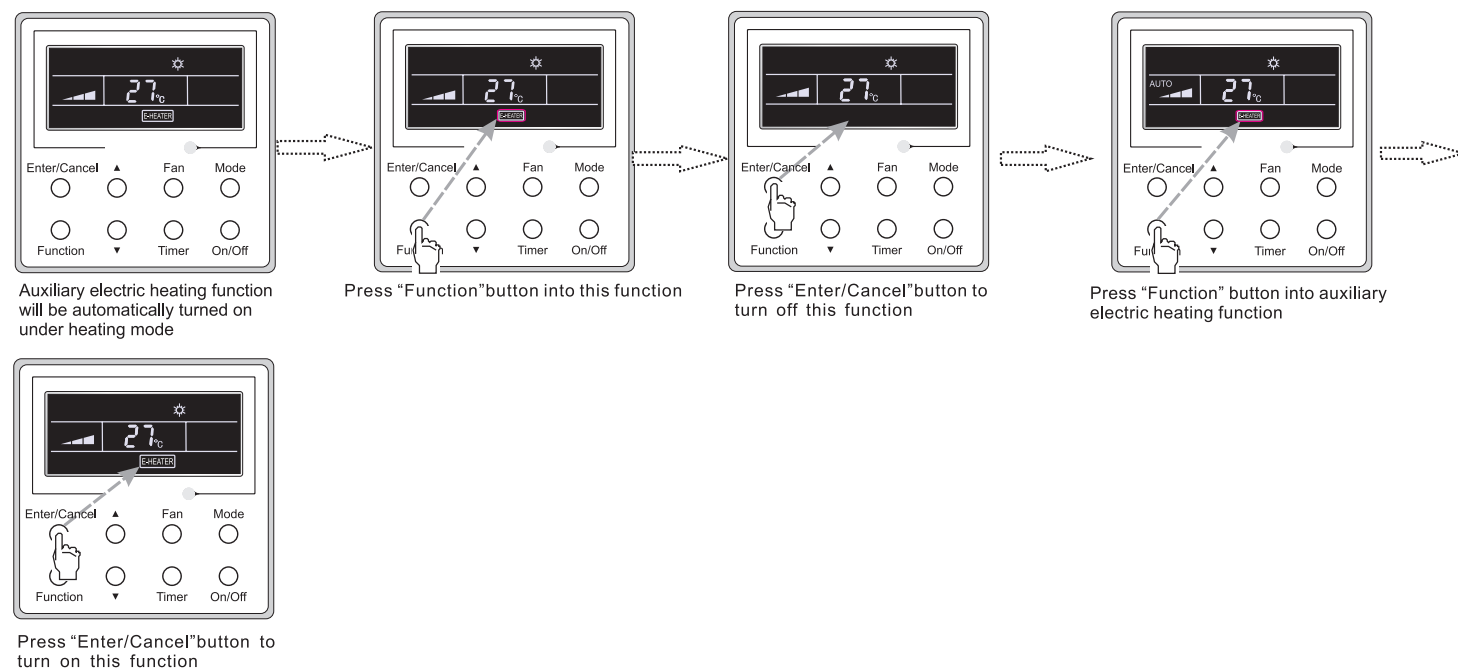

Fig.12 E-heater Setting

3.10 Blow Setting

Blow function: After the unit is turned off, the water in evaporator of indoor unit will be automatically evaporated to avoid mildew.

In the Cooling or Dry mode, press Function till the unit enters the Blow setting interface and then press Enter/Cancel to active this function.

When the Blow function is activated, press Function to the Blow setting interface and then press Enter/Cancel to cancel this function.

Blow function setting is as shown in Fig.13

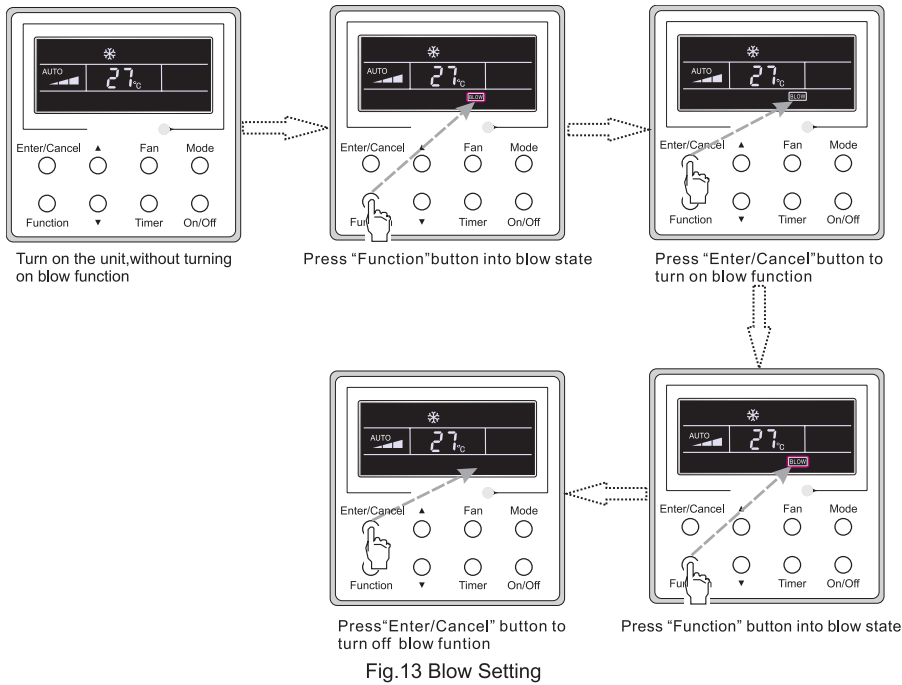

Notes:

- ① . When the Blow function is activated, if turning off the unit by pressing On/Off or by the remote controller, the indoor fan will run at the low fan speed for 2 min, with "BLOW" displayed on the LCD. While, if the Blow function is deactivated, the indoor fan will be turned off directly.
- ② . Blow function is unavailable in the Fan or Heating mode.

3.11 Other Functions

(1). Lock

Upon startup of the unit without malfunction or under the "Off" state of the unit, press ▲ and ▼ at the same time for 5s till the wired remote controller enters the Lock function. In this case, LCD displays . After that, repress these two buttons at the same time for 5s to quit this function. Under the Lock state, any other button press won't get any response.

(2). Memory

Memory switchover: Under the "Off" state of the unit, press Mode and ▲ at the same time for 5s to switch memory states between memory on and memory off. When this function is activated, Memory will be displayed. If this function is not set, the unit will be under the "Off" state after power failure and then power recovery.

Memory recovery: If this function has been set for the wired remote controller, the wired remote controller after power failure will resume its original running state upon power recovery.

Memory contents: On/Off, Mode, set temperature, set fan speed and Lock function.

(3). Selection of the Temperature Sensor

Under OFF state of the unit, press both "Function" and "Timer" for five seconds to go the commissioning status. Under this status, adjust the display in the temperature display area to "00" through the button "Mode", and then adjust the option of the temperature sensor in the timer display area through the button ▲ or ▼.

- ① . Indoor ambient temperature is sensed at the return air inlet(01 in the timer display area).
- ② . Indoor ambient temperature is the sensed at the wired controller(02 in the timer display area).
- ③ . Select the temperature sensor at the return air inlet under the cooling, dry and fan modes, while select the temperature sensor at the wired controller under the heating and auto modes.(03 in the timer display area).
- ④ . Select the temperature sensor at the wired controller under the cooling, dry and fan modes, and select the temperature sensor at the return air inlet under the heating mode and auto modes (04 displayed in the timer display area).

The factory defaulted setting is ③ .

After the setting, press "Enter/Cancel" to make a confirmation and quit this setting status.

Pressing the button "On/Off" also can quit this commissioning status but the set data won't be memorized.

Under the commissioning status, if there is no any operation in 20 seconds after the last button press, it will back to the previous state without memorizing the current data.

(4). Selection of the Fan Speed

Under OFF state of the unit, press both the buttons "Function" and "Timer" for five seconds to go to the commissioning status, and then adjust the display in the temperature display area to 01 through the button "Mode" and adjust the setting of the fan speed, which comes to two options.

01: Three low fan speeds; 02: Three high fan speeds

After the setting, press "Enter/Cancel" to make a confirmation and quit this setting status.

Pressing the button "On/Off" also can quit this commissioning status but the set data won't be memorized.

Under the commissioning status, if there is no any operation in 20 seconds after the last button press, it will back to the previous state without memorizing the current data.

4 Installation and Dismantlement

4.1 Connection of the Signal Line of the Wired Remote Controller

- Open the cover of the electric control box of the indoor unit.
- Let the single line of the wired remote controller through the rubber ring.
- Connect the signal line of the wired remote controller to the 4-pin socket of the indoor unit PCB.
- Tighten the signal wire with ties.
- The communication distance between the main board and the wired remote controller can be up to 20 meters (the standard distance is 8 meters)

4.2 Installation of the Wired Remote Controller

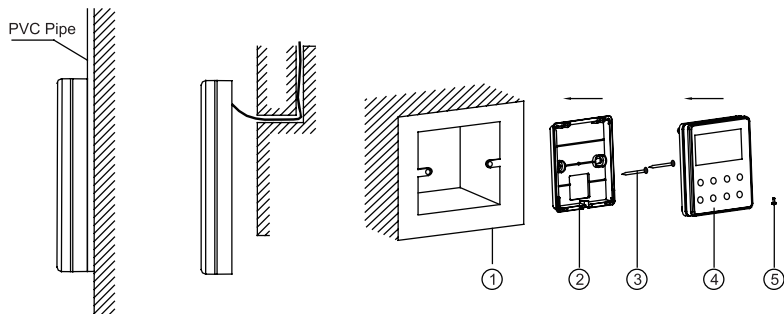

Fig.14 Accessories for the Installation of the Wired Remote Controller

Table 3

No.	1	2	3	4	5
Name	Socket box embedded in the wall	Soleplate of the Wired Remote Controller	Screw M4X25	Front Panel of the Wired Remote Controller	Screw ST2.9X6

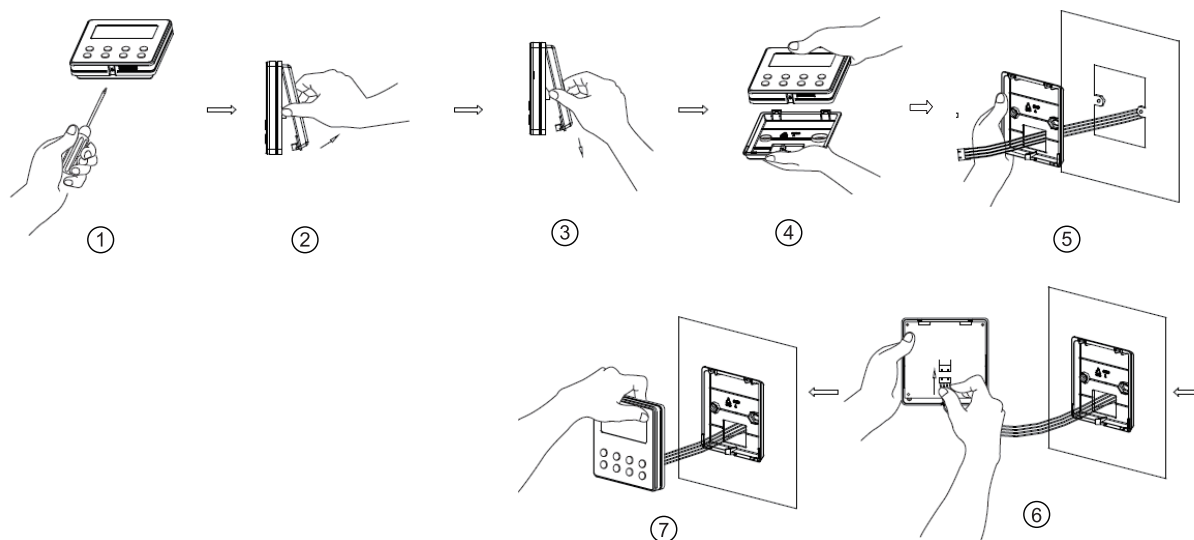

Fig.15 shows the installation steps of the wired remote controller, but there are some issues that need your attention.

- (1). Prior to the installation, please firstly cut off the power supply of the wire buried in the installation hole, that is, no operation is allowed with electricity during the whole installation.
- (2). Pull out the four-core twisted pair line from the installation holes and then let it go through the rectangular hole behind the soleplate of the wired remote controller.
- (3). Stick the soleplate of the wired remote controller to the wall over the installation hole and then fix it with screws M4X25.
- (4). Insert the four-core twisted pair line into the slot of the wired remote controller and then buckle the front panel and the soleplate of the wired remote controller together.
- (5). Finally, fix the front panel and the soleplate of the wired remote controller tightly by screws ST2.9X6.

⚠ CAUTION!

Please pay special attention to the followings during the connection to avoid the malfunction of the air conditioning unit due to electromagnetic interference.

- ①. Separate the signal and communication lines of the wired remote controller from the power

cord and connection lines between the indoor and outdoor unit, with a minimum interval of 20cm, otherwise the communication of the unit will probably work abnormally.

② . If the air conditioning unit is installed where is vulnerable to electromagnetic interference, then the signal and communication lines of the wired remote controller must be the shielding twisted pair lines.

4.3 Dismantlement of the Wired Remote Controller

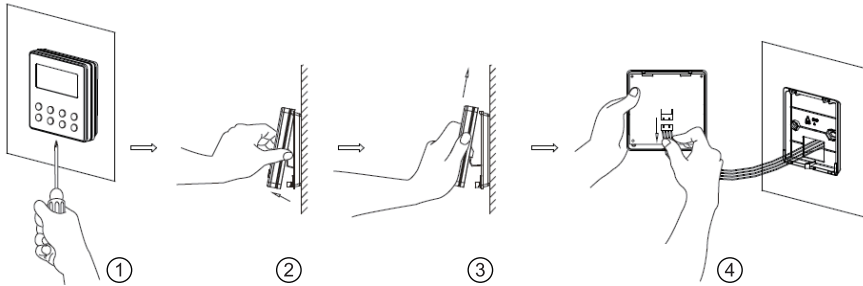

5 Errors Display

If there is an error occurring during the operation of the system, the error code will be displayed on the LCD, as show in Fig.16.

If multi errors occur at the same time, their codes will be displayed circularly.

Note: In event of any error, please turn off the unit and contact the professionally skilled personnel.

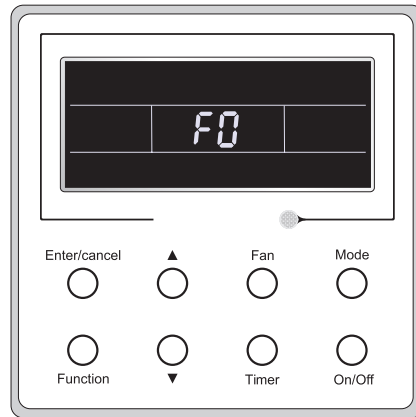

Fig.16

Table 4 Meaning of Each Error

Error	Error Code	Error	Error Code
Return air temperature sensor open/short circuited	F1	Drive board communication error	P6
evaporator temperature sensor open/short circuited	F2	Compressor overheating protection	H3
Indoor unit liquid valve temperature sensor open/short circuited	b5	Indoor and outdoor units unmatched	LP
Indoor gas valve temperature sensor open/short circuited	b7	Communication line misconnected or expansion valve error	dn
IPM temperature sensor open/short circuited	P7	Running mode conflict	E7
Outdoor ambient temperature sensor open/short circuited	F3	Pump-down	Fo
Outdoor unit condenser mid-tube temperature sensor open/short circuited	F4	Defrost or oil return	✳
Discharge temperature sensor open/short circuited	F5	Forced defrosting	H1
Indoor and outdoor communication error	E6	Compressor startup failure	Lc
DC bus under-voltage protection	PL	High discharge temperature protection	E4
DC bus over-voltage protection	PH	Overload protection	E8
Compressor phase current sensing circuit error	U1	Whole unit over-current protection	E5
Compressor demagnetization protection	HE	Over phase current protection	P5
PFC protection	Hc	Compressor desynchronizing	H7
IPM Temperature Protection	P8	IPM Current protection	H5

Over-power protection	L9	Compressor phase loss/reversal protection	Ld
System charge shortage or blockage protection	F0	Frequency restricted/reduced with whole unit current protection	F8
Capacitor charging error	PU	Frequency restricted/reduced with IPM current protection	En
High pressure protection	E1	Frequency restricted/reduced with high discharge temperature	F9
Low pressure protection	E3	Frequency restricted/reduced with anti-freezing protection	FH
Compressor stalling	LE	Frequency restricted/reduced with overload protection	F6
Over-speeding	LF	Frequency restricted/reduced with IPM temperature protection	EU
Drive board temperature sensor error	PF	Indoor unit full water error	E9
AC contactor protection	P9	Anti-freezing protection	E2
Temperature drift protection	PE	AC input voltage abnormal	PP
Sensor connection protection	Pd	Whole unit current sensing circuit error	U5
DC bus voltage drop error	U3	4-way valve reversing error	U7
Outdoor fan 1 error protection	L3	Motor stalling	H6
Outdoor fan 2 error protection	LA	PG motor zero-crossing protection	U8

Part II : Installation and Maintenance

7. Indoor Unit Installation

7.1 Installation of Duct Type

7.1.1 Installation Location and Matters Needing Attention

- ◆ The installation of air conditioner unit must be in accordance with national and local safety codes.
- ◆ Installation quality will directly affect the normal use of air conditioner unit. The user is prohibited from installation by himself. Please contact your dealer after buying this machine. Professional installation workers will provide installation and test services according to installation manual.
- ◆ Do not connect to power until all installation work is completed.

7.1.2 How to select the installation location for the indoor unit

- ◆ Where there is no direct sunlight.
- ◆ Where the top hanger, ceiling and the building structure are strong enough to withstand the weight of the unit.
- ◆ Where the drain pipe can be easily connected to outside.
- ◆ Where the flow of the air inlet and outlet are not blocked.
- ◆ Where the refrigerant pipe of the indoor unit can be easily led to outside.
- ◆ Where there is no inflammable, explosive substance or their leakage.
- ◆ Where there is no corrosive gas, heavy dust, salt mist, smog or moisture.

7.1.3 Caution for Installation

- ◆ Ensure the hanger is strong enough to withstand the weight of the unit.
- ◆ The drainage of the drain pipe is easy.
- ◆ No obstacle is in the inlet/outlet and the air circulation is in good condition.
- ◆ Ensure the installation space is left for the access to maintenance.
- ◆ It should be far away from where there is heat source, leakage of inflammable, explosive substances, or smog.
- ◆ It is the ceiling type unit (concealed in the ceiling).
- ◆ The power cords and connection lines of the indoor and outdoor units must be at least 1m away from the TV set or radio to avoid the image interference and noise (even if 1m is kept, the noise may be produced due to the strong electric wave).

7.1.4 Outline Dimension Drawings of the Indoor Unit

Note: the unit in the followings figures is mm, unless otherwise specified.

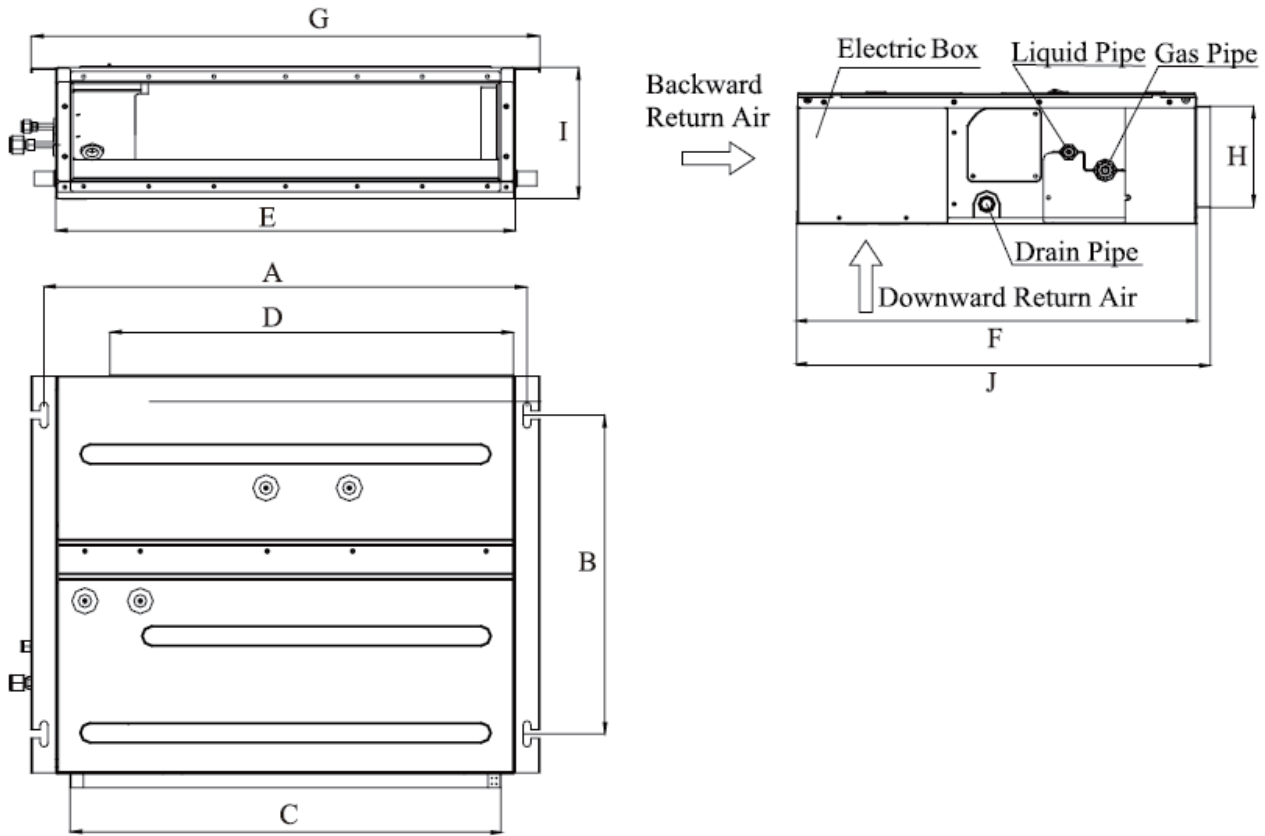

Model	A	B	C	D	E	F	G	H	I	J
09/12K	742	491	662	620	700	615	782	156	200	635
18K	942	491	862	820	900	615	982	156	200	635
24K	1142	491	1062	1020	1100	615	1182	156	200	635

7.1.5 Dimension Requirements on the Installation Space of the Indoor Unit

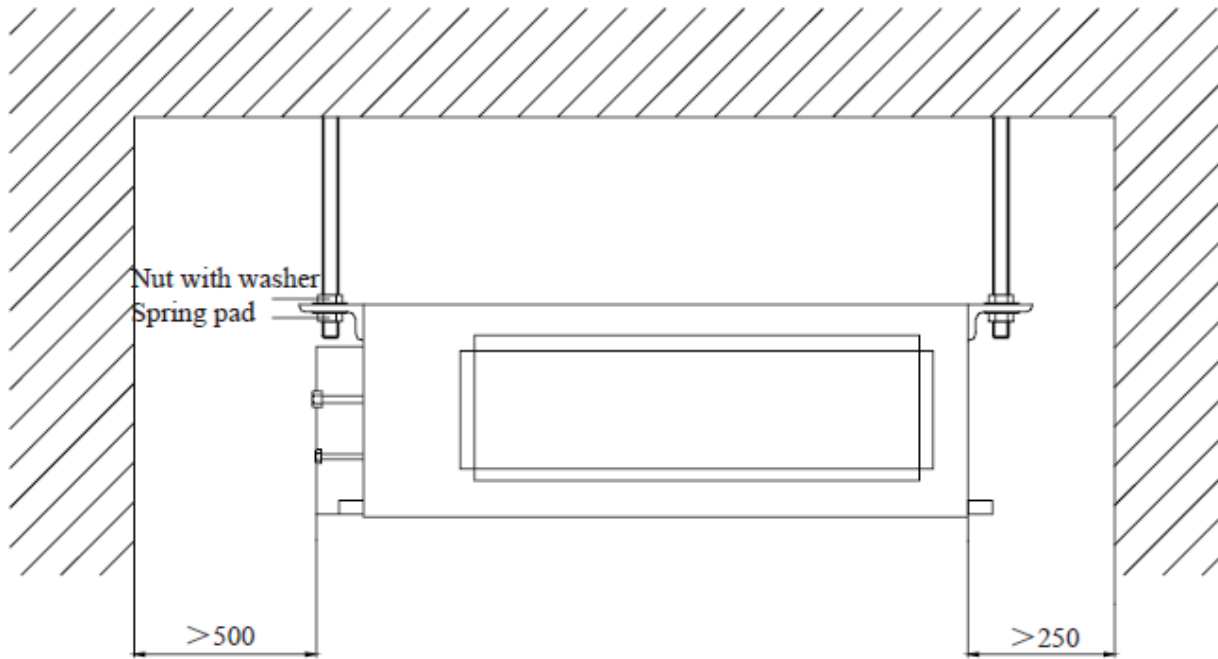

7.1.6 Installation of the Indoor Unit

1) Requirements on the Installation Location

- ◆ Ensure the hanger is strong enough to withstand the weight of the unit.
- ◆ The drainage of the drain pipe is easy.
- ◆ No obstacle is in the inlet/outlet and the air circulation is in good condition.
- ◆ Ensure the installation space shown in the following figures is left for the access to maintenance.
- ◆ It should be far away from where there is heat source, leakage of inflammable, explosive substances, or smog.
- ◆ It is the ceiling type unit (concealed in the ceiling).
- ◆ The power cords and connection lines of the indoor and outdoor units must be at least 1m away from the TV set or radio to avoid the image interference and noise (even if 1m is kept, the noise may be produced due to the strong electric wave).

2) Installation of the Indoor Unit

Insert the M10 expansion bolt into the hole, and then knock the nail into the bolt. Refer to the Outline Dimension Drawings of the Indoor Unit for the distance between holes and see the following figures for the installation of the expansion bolt.

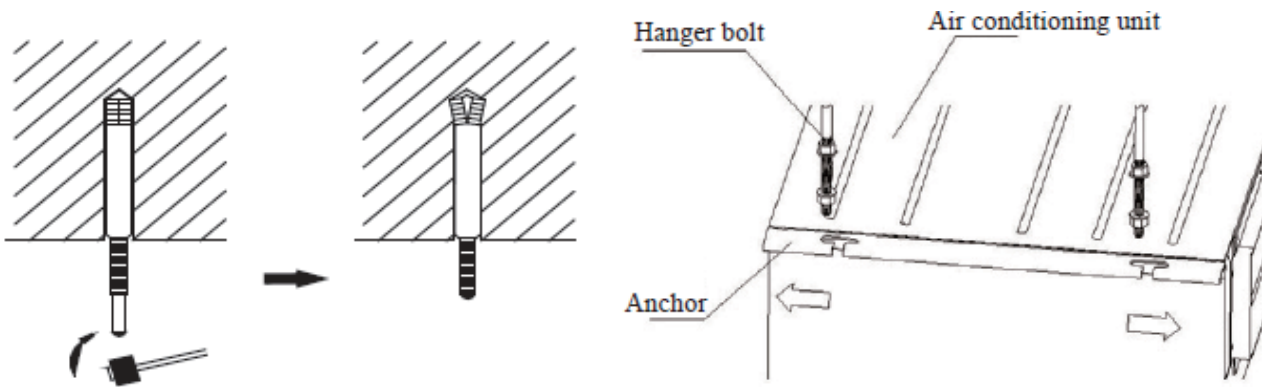

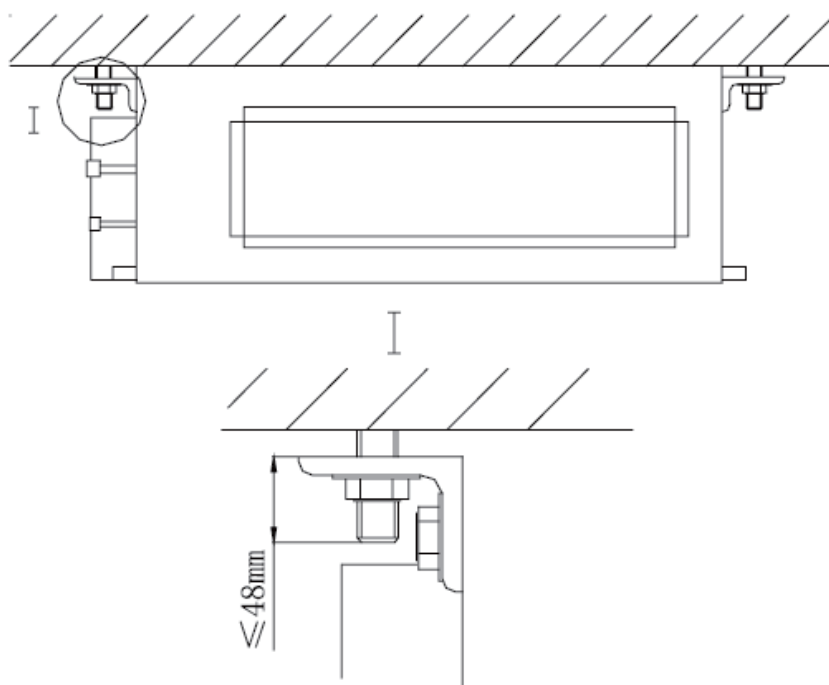

⚠ Caution!

- ◆ Prior to the installation, please make a good preparation for all piping (refrigerant pipe, drain pipe) and wiring (wires of the wired controller, wires between the indoor and outdoor unit) of the indoor unit to make the further installation much easier.
- ◆ If there is an opening in the ceiling, it is better to reinforce it to keep it flat and prevent it vibrating. Consult the user and builder for more details.
- ◆ If the strength of the ceiling is not strong enough, a beam made of angle iron can be used and then fix the unit on it.
- ◆ If the indoor unit is not installed in the air conditioning area, please use sponge around the unit to prevent condensing. The thickness of the sponge depends on the actual installation environment.

7.1.7 Horizontality Check of the Indoor Unit

After the installation of the indoor unit, its horizontality must be checked to make sure the unit keep horizontal fore and aft and keep an inclination of 5° toward the drain pipe right and left.

Horizontality Check Device

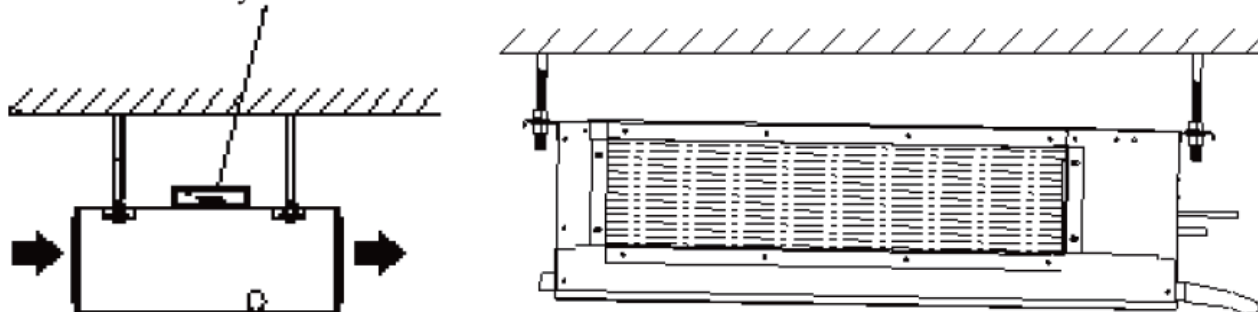

7.1.8 Installation of the Air Supply Duct

- 1) Installation of the Rectangular Air Supply Duct

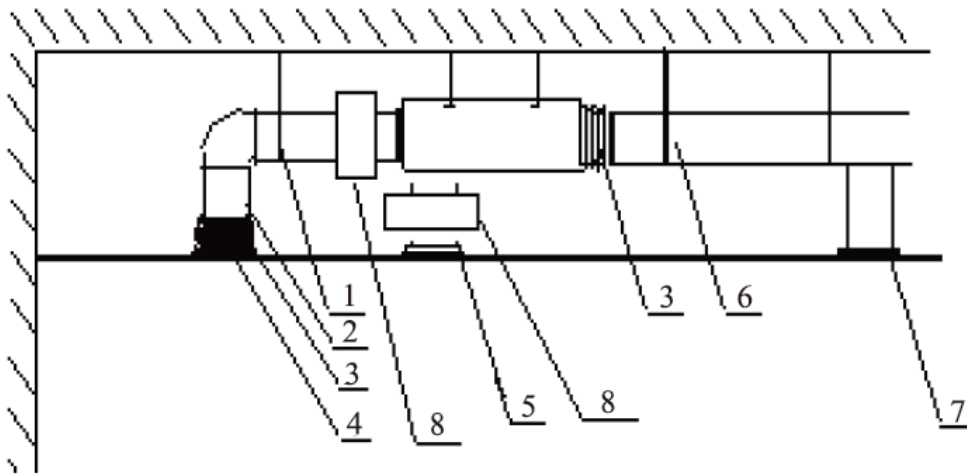

No.	Name	No.	Name	No.	Name
1	Hanger	4	Return Air Inlet	7	Air Supply Outlet
2	Return Air Duct	5	Filter Screen	8	Plenum Box
3	Canvas Duct	6	Main Air Supply Duct		

2) Installation of the Round Air Supply Duct

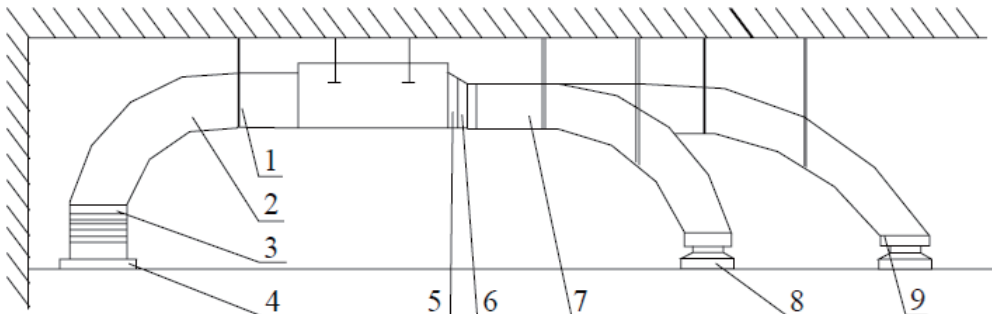

No.	Name	No.	Name	No.	Name
1	Hanger	4	Return Air Louver	7	Air Supply Duct
2	Return Air Duct	5	Air Supply Outlet	8	Diffuser
3	Canvas Duct	6	Transition Duct	9	Diffuser Joint

3) Installation Steps of the Round Air Supply Duct

- ◆ Preinstall the outlet of the round duct on the transition duct and then fix it by the self-tapping screw.
- ◆ Place the transition duct to the air outlet of the unit and fix it with rivet.
- ◆ Connect the outlet to the duct and then tighten them with tape. Other installation details are not covered herein.

⚠ Caution !

- ◆ The maximum length of the duct means the maximum length of the air supply duct plus the maximum length of the return air duct.
- ◆ For the unit with the auxiliary electric heating function, if the round duct is to be adopted, then the straight length of the transition duct cannot be less than 200mm.
- ◆ The duct is either rectangular or round and connected with the air inlet/outlet of the indoor unit. Among all air supply outlets, at least one should be kept open. As for the round duct, it needs a transition duct of which the size should match with the air supply outlet of the unit. After the fitting of the transition duct, it is the turn of the round duct, which is better to be kept 10 meters far away from the corresponding diffuser. The standard accessories supplied by GREE is the transition duct 200mm long and round air outlet φ200, however, those of other specifications can be purchased.

7.1.9 Installation of the Return Air Duct

- 1) The default installation location of the rectangular flange is in the back and the return air cover plate is in the bottom.

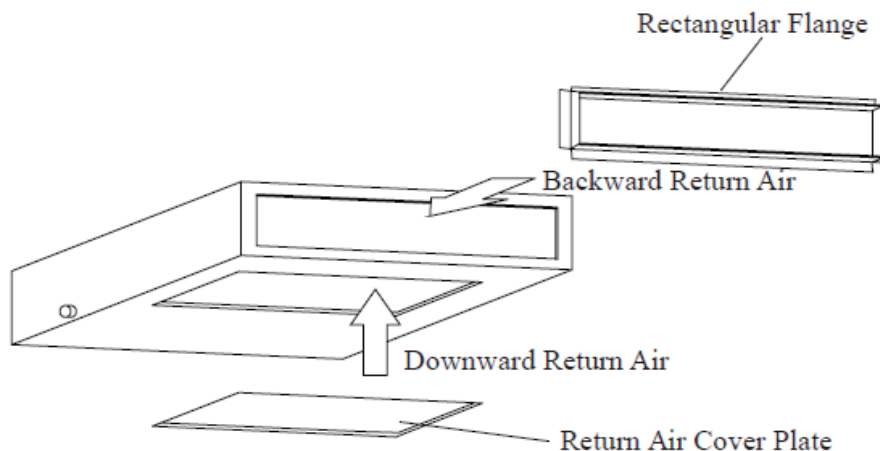

- 2) If the downward return air is desired, just change the place of the rectangular flange and the return air cover plate.
- 3) Connect one end of the return air duct to the return air outlet of the unit by rivets and the other to the return air louver. For the sake of the convenience to freely adjust the height, a cutting of canvas duct will be helpful, which can be reinforce and folded by 8# iron wire.
- 4) More noise is likely to be produced in the downward return air mode than the backward return air mode, so it is suggestive to install a silencer and a plenum box to minimize the noise.
- 5) The installation method can be chose with considering the conditions of the building and maintenance etc.

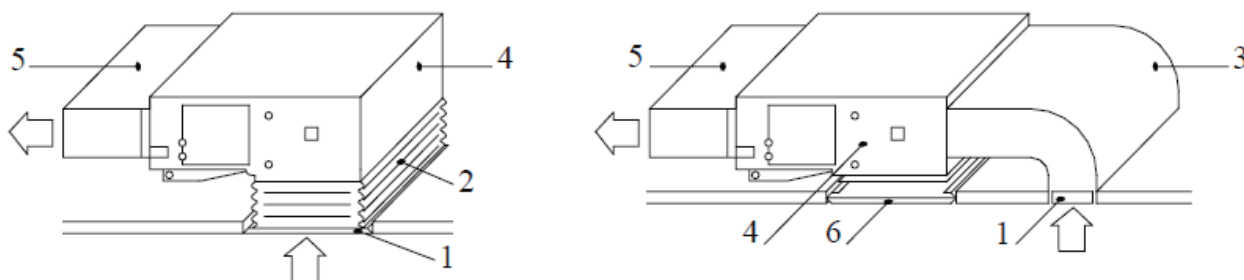

No.	Name	No.	Name
1	Return Air Louver(with the filter screen)	4	Indoor Unit
2	Canvas Duct	5	Air Supply Duct
3	Return Air Duct	6	Access Grille

7.1.10 Installation of the Condensate Pipe

- 1) The condensate pipe should keep a inclination angle of 5~10°, which can facilitate the drainage of the condensate water. And the joints of the condensate pipe should be insulated by the insulation material to prevent condensing.

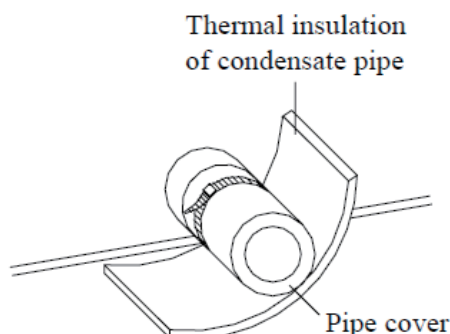

- 2) There is a condensate outlet on both left and right sides of the unit. Once one is confirmed to be used, the other should be clogged by a rubber plug, bundled by the binding wire and insulated by the insulation material to avoid water leakage.
- 3) The right outlet is defaulted to be clogged with a plug.

⚠ Caution! :No water leakage is allowed on the joint of the condensate pipe.

7.1.11 Design of the Drain Pipe

- 1) The drain pipe should always keep an inclination angle($1/50\sim 1/100$) to avoid the water gathering in some certain place.
- 2) During the connection of the drain pipe and device, do not impose too much force on the pipe on one side of the device and the pipe should be fixed as close as to the device.
- 3) The drain pipe can be the ordinary hard PVC pipe which can be purchased locally. During the connection, inset the end of the PVC pipe to the drain outlet, then tighten it with the drain hose and binding wire but never connect the drain outlet and the drain hose by adhesive.
- 4) When the drain pipe is used for multiple devices, the public section of the pipe should be 100mm lower than the drain hole of each device and it is better to use the much thicker pipe for such a purpose.

7.1.12 Installation of the Drain Pipe

- 1) The diameter of the drain pipe should be larger or equal to that of the refrigerant pipe (PVC pipe, outer diameter:25mm, wall thickness ≥ 1.5 mm).
- 2) The drain pipe should be as short as possible and with at least a $1/100$ degree of slope to avoid forming air pockets.
- 3) If the proper degree of slope of the drain pipe is not allowed, a lift pipe should be installed.
- 4) A distance 1-1.5m should be kept between the hangers to avoid the drain hose making a turn.

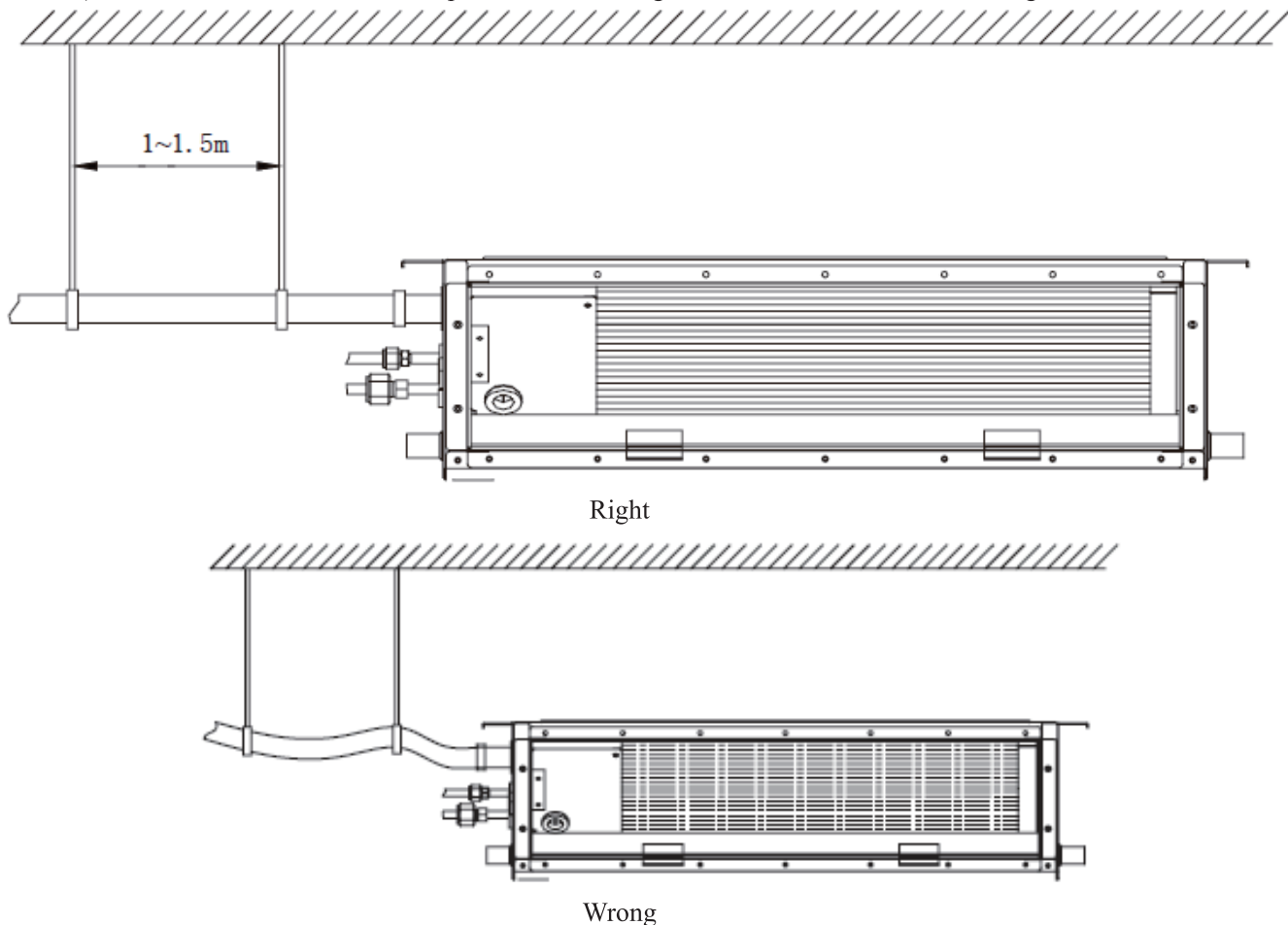

- 5) Insert the drain hose into the drain hole and tighten it with clamps.
- 6) Wrap the clamps with large amount of sponge for thermal insulation.
- 7) The drain hose inside the room also should be insulated.

7.1.13 Precautions for the Lift Pipe

The installation height of the lift pipe should be less than 850mm. It is recommended to set an inclination angle $1^{\circ}\sim 2^{\circ}$ for the lift pipe toward the drainage direction. If the lift pipe and the unit form a right angle, the height of the lift pipe must be less than 800mm.

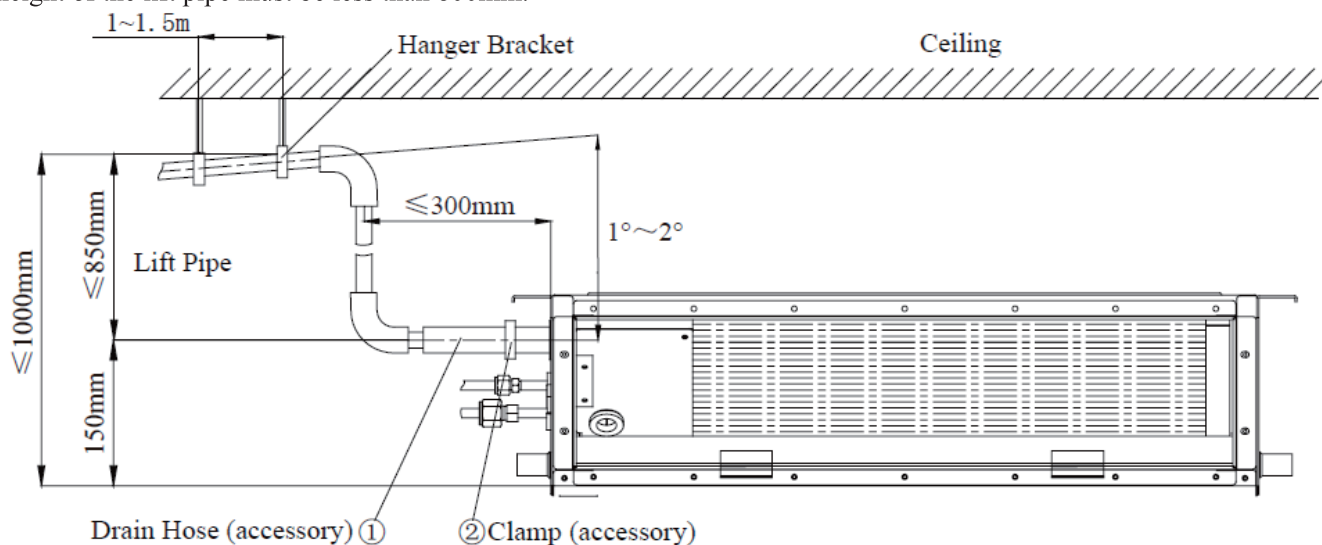

Notes:

- ①. The inclination height of the drain hose should be within 75mm so that the outlet of the drain hose does not suffer the external force.
- ②. If multiple drain pipes converge, please follow the installation steps below.

I - Joint of drain pipe

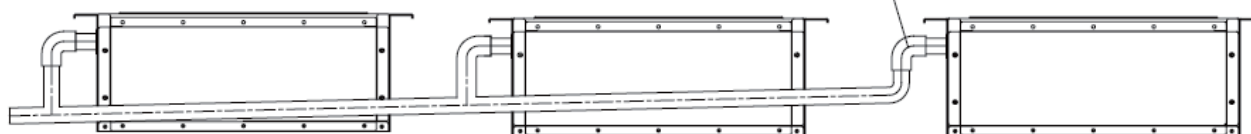

The specification of the joint of the drain pipe should be suitable to the running capacity of the unit

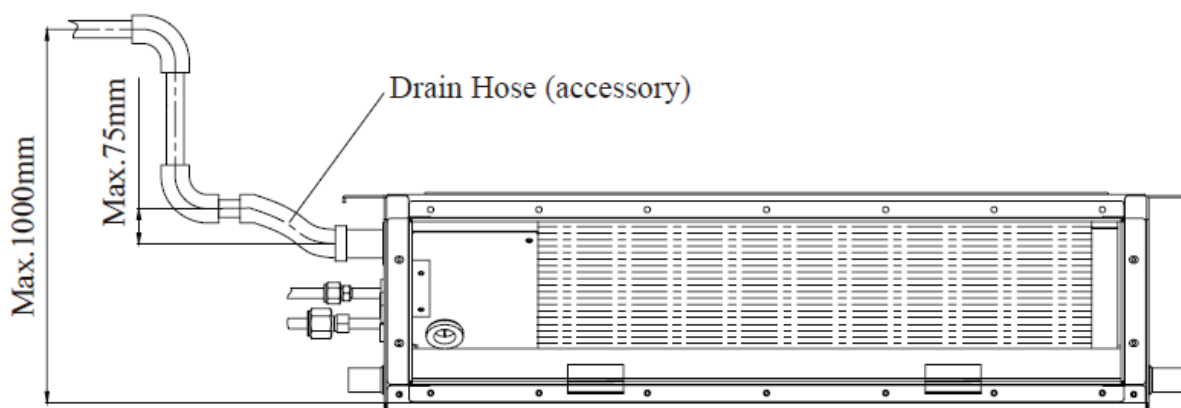

Please read this operating manual carefully before operating the unit.



Appliance filled with flammable gas R32.



Before use the appliance, read the owner's manual first.



Before install the appliance, read the installation manual first.



Before repair the appliance, read the service manual first.

The figures in this manual may be different with the material objects, please refer to the material objects for reference.

● The Refrigerant

- To realize the function of the air conditioner unit, a special refrigerant circulates in the system. The used refrigerant is the fluoride R32, which is specially cleaned. The refrigerant is flammable and odorless. Furthermore, it can lead to explosion under certain conditions. But the flammability of the refrigerant is very low. It can be ignited only by fire.
- Compared to common refrigerants, R32 is a nonpolluting refrigerant with no harm to the ozone layer. The influence upon the greenhouse effect is also lower. R32 has got very good thermodynamic features which lead to a really high energy efficiency. The units therefore need a less filling.

WARNING:

Do not use means to accelerate the defrosting process or to clean, other than those recommended by the manufacturer. Should repair be necessary, contact your nearest authorized Service Centre.

Any repairs carried out by unqualified personnel may be dangerous.

The appliance shall be stored in a room without continuously operating ignition sources. (for example: open flames, an operating gas appliance or an operating electric heater.)

Do not pierce or burn.

Appliance shall be installed, operated and stored in a room with a floor area larger than "X"m² (see table 1). (only applies to appliances that are not fixed appliances)

Appliance filled with flammable gas R32. For repairs, strictly follow manufacturer's instructions only.

Be aware that refrigerants do not contain odour.

Read specialist's manual.

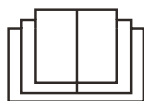

Safety operation of flammable refrigerant

Qualification requirement for installation and maintenance man

- All the work men who are engaging in the refrigeration system should bear the valid certification awarded by the authoritative organization and the qualification for dealing with the refrigeration system recognized by this industry. If it needs other technician to maintain and repair the appliance, they should be supervised by the person who bears the qualification for using the flammable refrigerant.
- It can only be repaired by the method suggested by the equipment's manufacturer.

Installation notes

- The air conditioner is not allowed to use in a room that has running fire (such as fire source, working coal gas ware, operating heater).
- It is not allowed to drill hole or burn the connection pipe.
- The air conditioner must be installed in a room that is larger than the minimum room area. The minimum room area is shown on the nameplate or following table a.
- Leak test is a must after installation.

table a - Minimum room area (m²)

Minimum room area(m ²)	Charge amount (kg)	≤1.2	1.3	1.4	1.5	1.6	1.7	1.8	1.9	2	2.1	2.2	2.3	2.4	2.5
	floor location		4	14.5	16.8	19.3	22	24.8	27.8	31	34.3	37.8	41.5	45.4	49.4
window mounted		4	5.2	6.1	7	7.9	8.9	10	11.2	12.4	13.6	15	16.3	17.8	19.3
wall mounted		4	4	4	4	4	4	4	4	4	4.2	4.6	5	5.5	6
ceiling mounted		4	4	4	4	4	4	4	4	4	4	4	4	4	4

Maintenance notes

- Check whether the maintenance area or the room area meet the requirement of the nameplate.
 - It's only allowed to be operated in the rooms that meet the requirement of the nameplate.
- Check whether the maintenance area is well-ventilated.
 - The continuous ventilation status should be kept during the operation process.
- Check whether there is fire source or potential fire source in the maintenance area.
 - The naked flame is prohibited in the maintenance area; and the "no smoking" warning board should be hanged.
- Check whether the appliance mark is in good condition.
 - Replace the vague or damaged warning mark.

Welding

- If you should cut or weld the refrigerant system pipes in the process of maintaining, please follow the steps as below:
 - a. Shut down the unit and cut power supply
 - b. Eliminate the refrigerant
 - c. Vacuuming
 - d. Clean it with N2 gas
 - e. Cutting or welding
 - f. Carry back to the service spot for welding
- The refrigerant should be recycled into the specialized storage tank.
- Make sure that there isn't any naked flame near the outlet of the vacuum pump and it's well-ventilated.

- **Filling the refrigerant**

- Use the refrigerant filling appliances specialized for R32. Make sure that different
- kinds of refrigerant won't contaminate with each other.
- The refrigerant tank should be kept upright at the time of filling refrigerant.
- Stick the label on the system after filling is finished (or haven't finished).
- Don't overfilling.

After filling is finished, please do the leakage detection before test running; another time of leak detection should be done when it's removed.

- **Safety instructions for transportation and storage**

- Please use the flammable gas detector to check before unload and open the container.
- No fire source and smoking.

According to the local rules and laws.

8. Maintenance

8.1 Error Code List

NO.	Name of malfunction	Indoor unit displaying method				AC status	Malfunctions
		Double 8 code display	Indicator display(LED blinks 0.5s-ON/0.5s-OFF)				
			Running LED	Cooling LED	Heating LED		
1	Indoor ambient sensor open circuit,short circuit	F1		Off 3s blink once		Cooling,dehumidifying:indoor fan motor is runing,other overloads will stop;Heating,whole unit will stop to run.	1.Room temp.sensor is not connected with the control panel AP1 2.Room temp.sensor is damaged
2	Indoor evaporator sensor circuit open,short circuit	F2		Off 3s blink twice		Cooling,dehumidifying;indoor fan motor runing,other overload will stop;Heating,whole unit will stop.	1,Tube temp.sensor is not connected with the conrtol panel AP1 2.Tube tmep.sensor is damaged
3	Indoor and outdoor units communication malfunction	E6	Off 3s blink 6 times			Cooling,compressor will stop,indoor fan motor works,Heating:all will stop	Please refer to troubleshooting
4	In defect of refrigerant	F0				The Dual-8 Code Display will show F0 and the complete unit stops.	1. In defect of refrigerant; 2. Indoor evaporator temperature sensor works abnormally; 3. The unit has been plugged up somewhere.
5	Full water protection	E9				Water level switch	If cut-off of water level switch is detected for 8s successively once energized, the system will enter full water protection. In this case, switch off the unit and then switch it on to eliminate this malfunction.

8.2 Troubleshooting for Main Malfunction

●Indoor unit:

1. Malfunction of Temperature Sensor F1, F2

Main detection points:

- Is the wiring terminal between the temperature sensor and the controller loosened or poorly contacted?
- Is there short circuit due to trip-over of the parts?
- Is the temperature sensor broken?
- Is mainboard broken?

Malfunction diagnosis process:

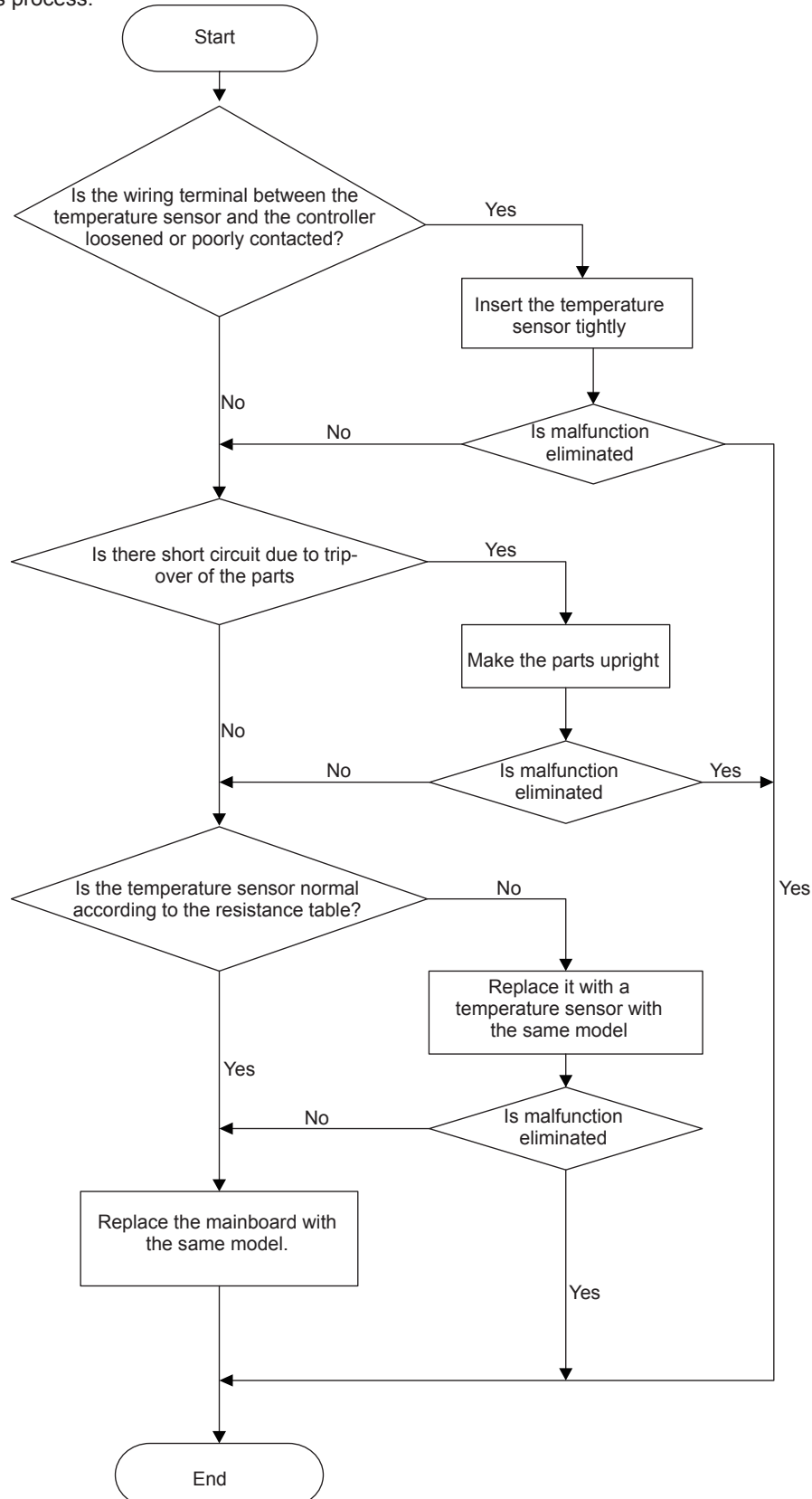

2. Communication malfunction E6

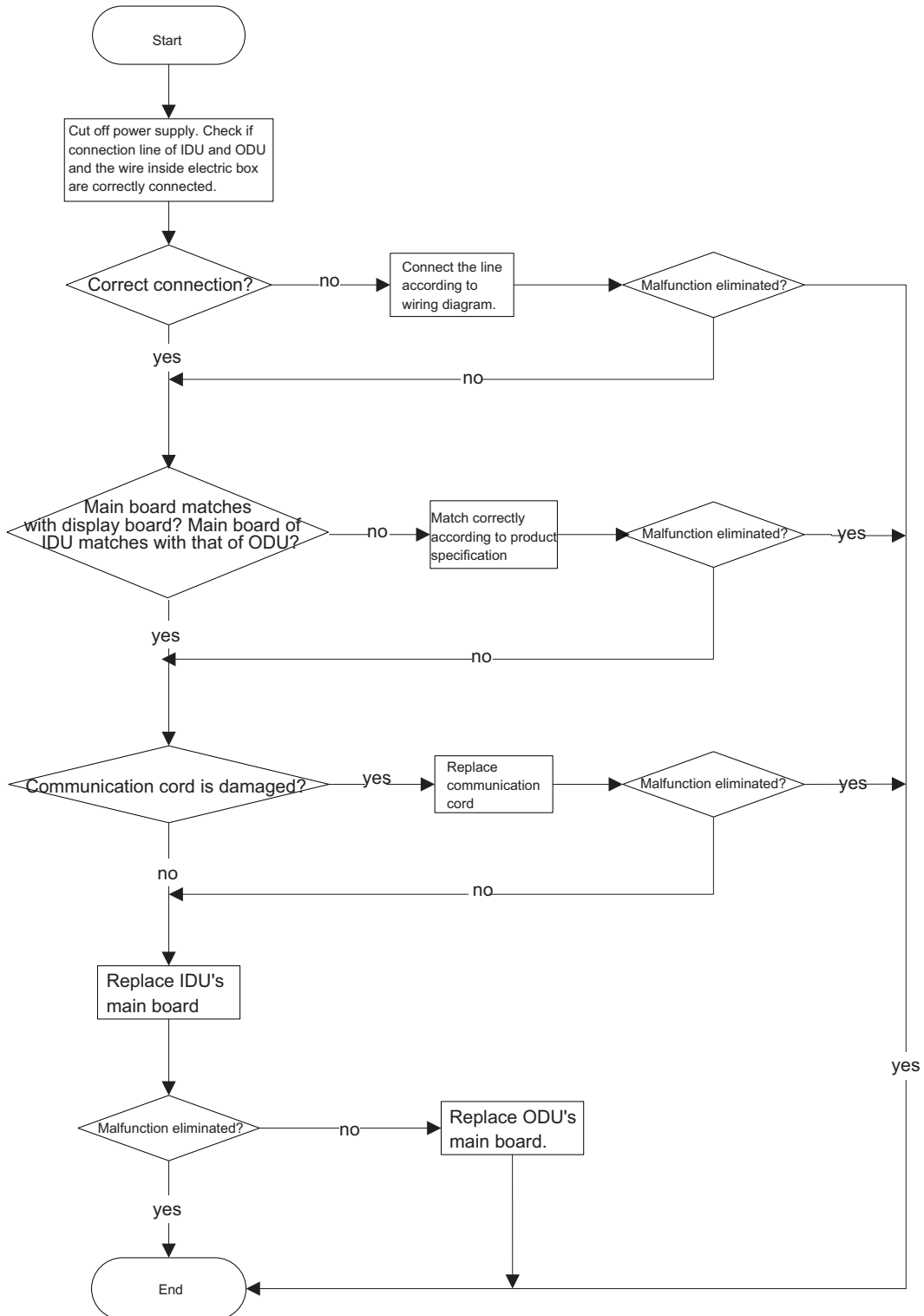

3.E9 Full Water Protection

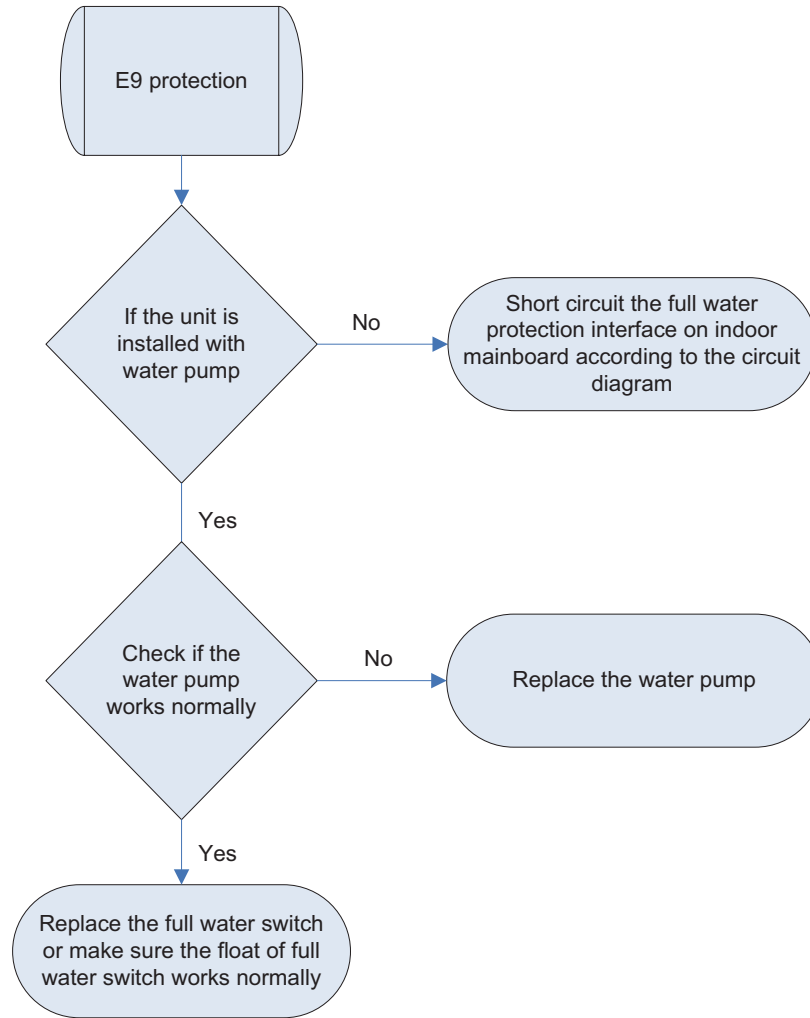

4. Malfunction of Insufficient fluorine protection F0

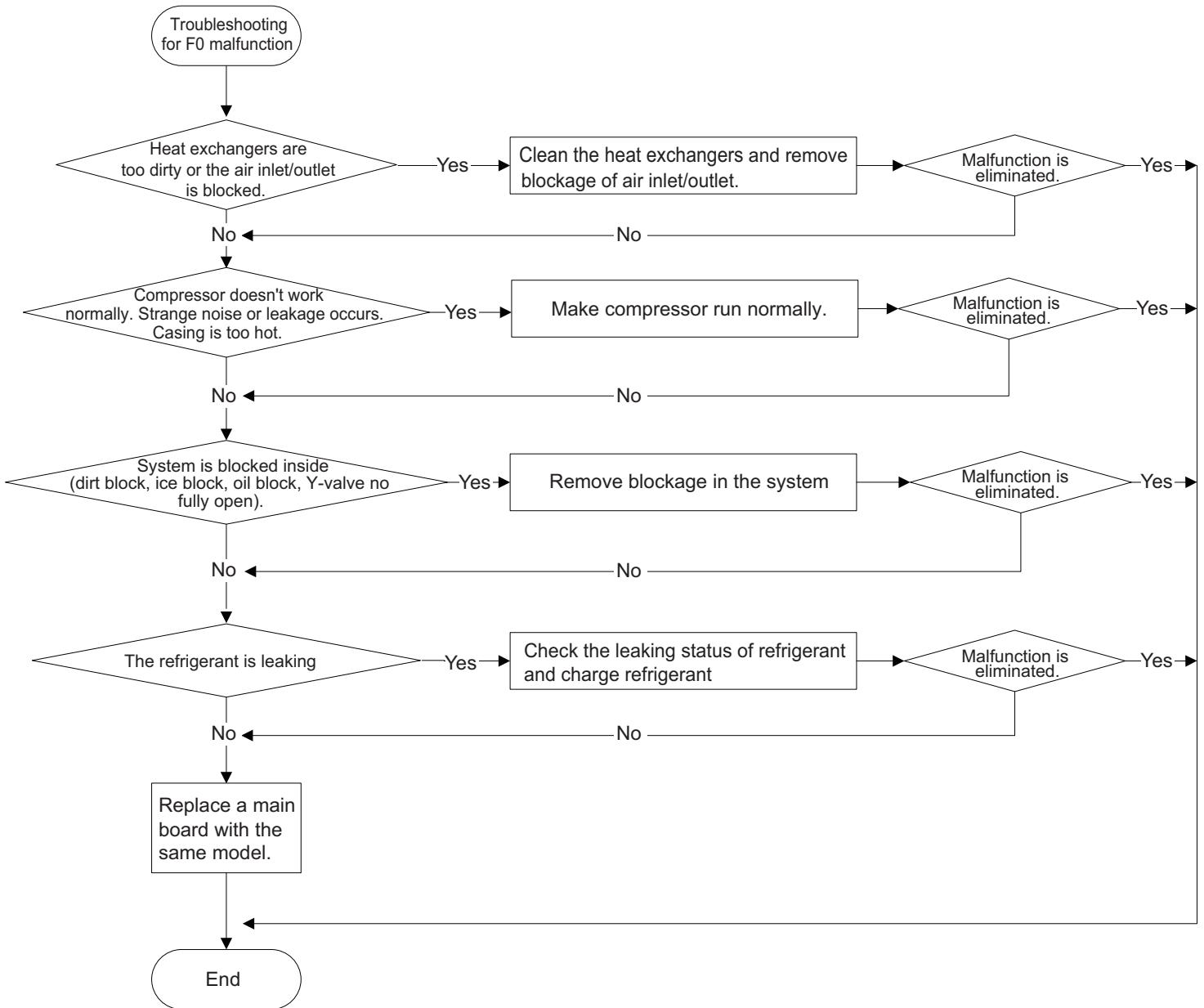

10. Removal Procedure

! Caution: discharge the refrigerant completely before removal.

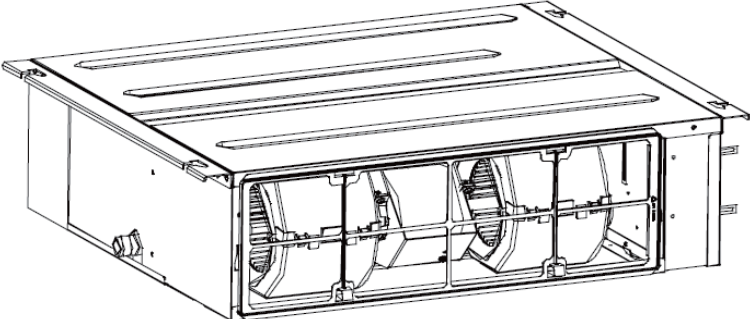
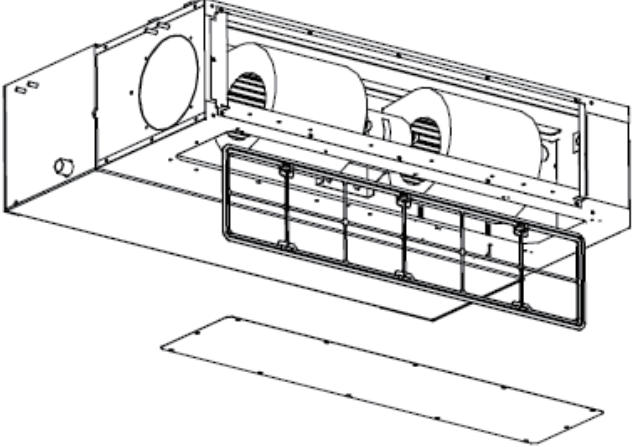
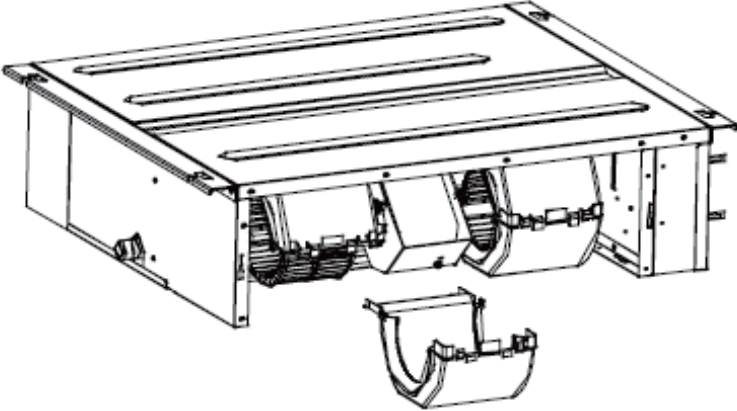
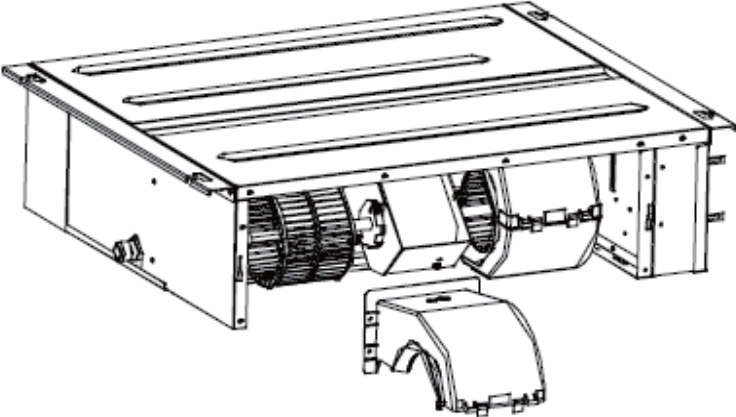
Steps	Illustrations	Operation Instructions
<p>1. Pull out the electric wire of the motor</p>		<p>Open the cover plate of the electric box and then pull out the electric wire inside the box.</p>
<p>2. Remove the cover plate for return air</p>		<ul style="list-style-type: none"> a) Remove the filter screen b) Unscrew the fixed screws of the return air
<p>3. Remove the rear volute</p>		<p>Undo the buckle of the rear and front volutes and then remove the rear volute away.</p>
<p>4. Remove the front volute</p>		<p>Unscrew the fixed screws of the front volute and then remove it away</p>

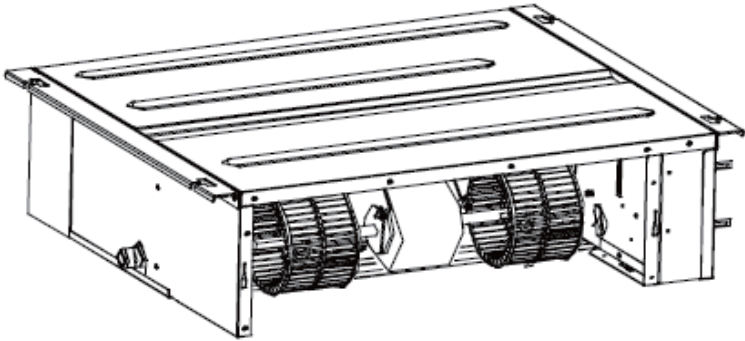
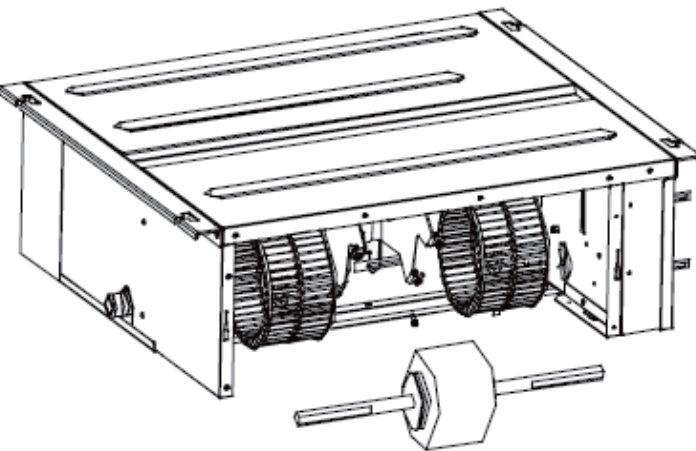
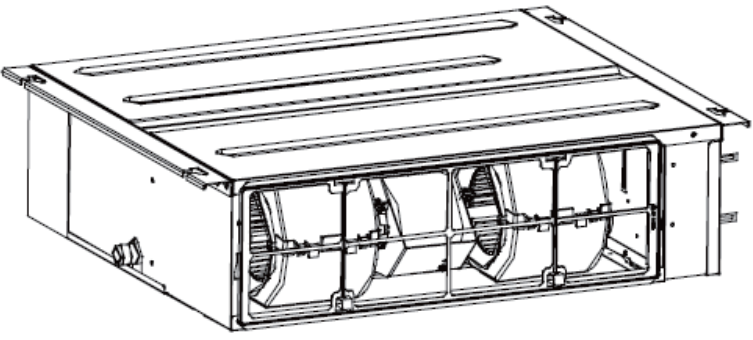
<p>5. Loosen the fan blade and fan motor</p>		<p>Unscrew the fixed screws of the fan blades and then undo the buckle of the motor</p>
<p>6. Remove the motor away.</p>		<p>a) Separate the motor away from the motor support. b) Remove the fan blade c) Take the motor out from the return air frame</p> <p>Note: the motor support shall be removed in advance and then changed to the unit.</p>
<p>7. Replace with a new motor</p>		<p>Assemble the fan as the reverse disassembly order and then take a power-on test.</p>

MULTI VARIABLE SERIES DUCT

**MV-D09BI, MV-D12BI,
MV-D18BI, MV-D24BI**



MV-D09BI

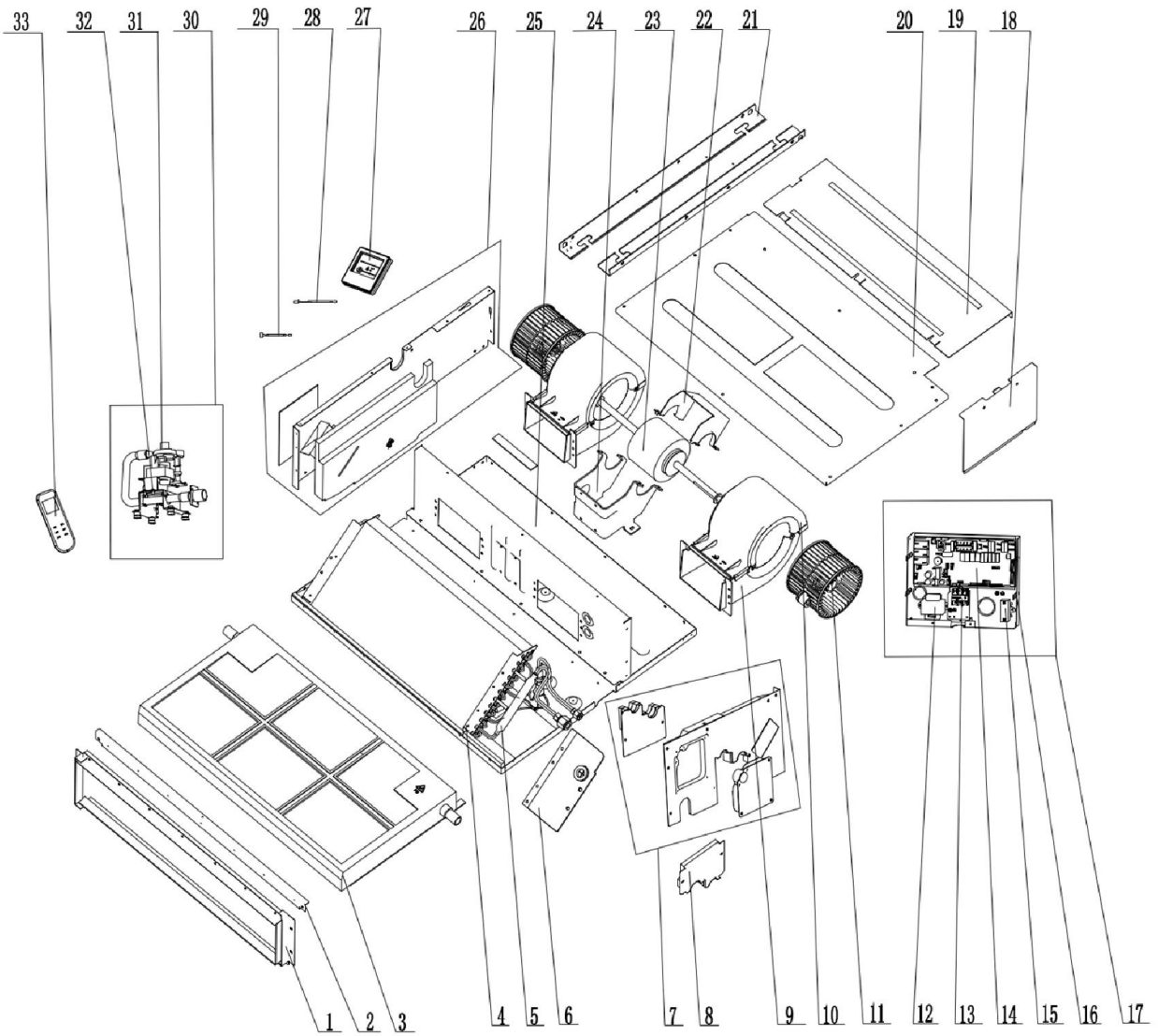

No	Description	Part Code	Note	Qty	Price Code
MODEL: MV-D09BI Duct unit					
1	Air outlet frame assy	01865216		1	AH
2	Cover of air outlet	01265298		1	AG
3	Water Tray Assy	01285332		1	AW
4	Top Cover Board Assy	01265200099		1	AT
5	Evaporator Assy	011001060406		1	BE
6	Sealplate sub-assy (evaporator)	01495317		1	AH
7	Left Side Plate Assy	01315334		1	AK
8	Sealplate sub-assy (outlet)	01495316		1	AE
9	Front Volute Casing	26905205		2	AH
10	Rear Volute Casing	26905206		2	AH
11	Centrifugal Fan	10425200		2	AR
12	Transformer	4311023303		1	AM
13	Terminal Board	420001000002		1	AF
14	Main Board	30226338		1	AY
15	Capacitor CBB61S	3301074704		1	AH
16	Electric Box Sub-Assy	01395100		1	AM
17	Electric Box Assy	01395983		1	BB
18	Electric Box Cover	01424253		1	AF
19	Cover board (Fan motor)	01265300		1	AM
20	Bottom Cover Plate	01265299		1	AP
21	Supporter	01895225		2	AH
22	Bar Clasp	012133000018		2	AB
23	Fan Motor	1570520103		1	BB
24	Motor Support	01804348		1	AK
25	Fan Motor Mounting Plate Sub-Assy	01325200007		1	AP
26	Right Side Plate Assy	01315335		1	AM
27	Display Board	300001060284_L41851		1	-
28	Ambient Temperature Sensor	39000206		1	AD
29	Temperature Sensor	390001982G		1	AD
30	Water Pump Assy	15405200082		1	BD
31	Water Level Switch	45020216		1	AQ
32	Water Pump	43130324		1	BC
33	Remote Controller	305100491_L41851		1	AT

The data are subject to change without notice.

MV-D12BI

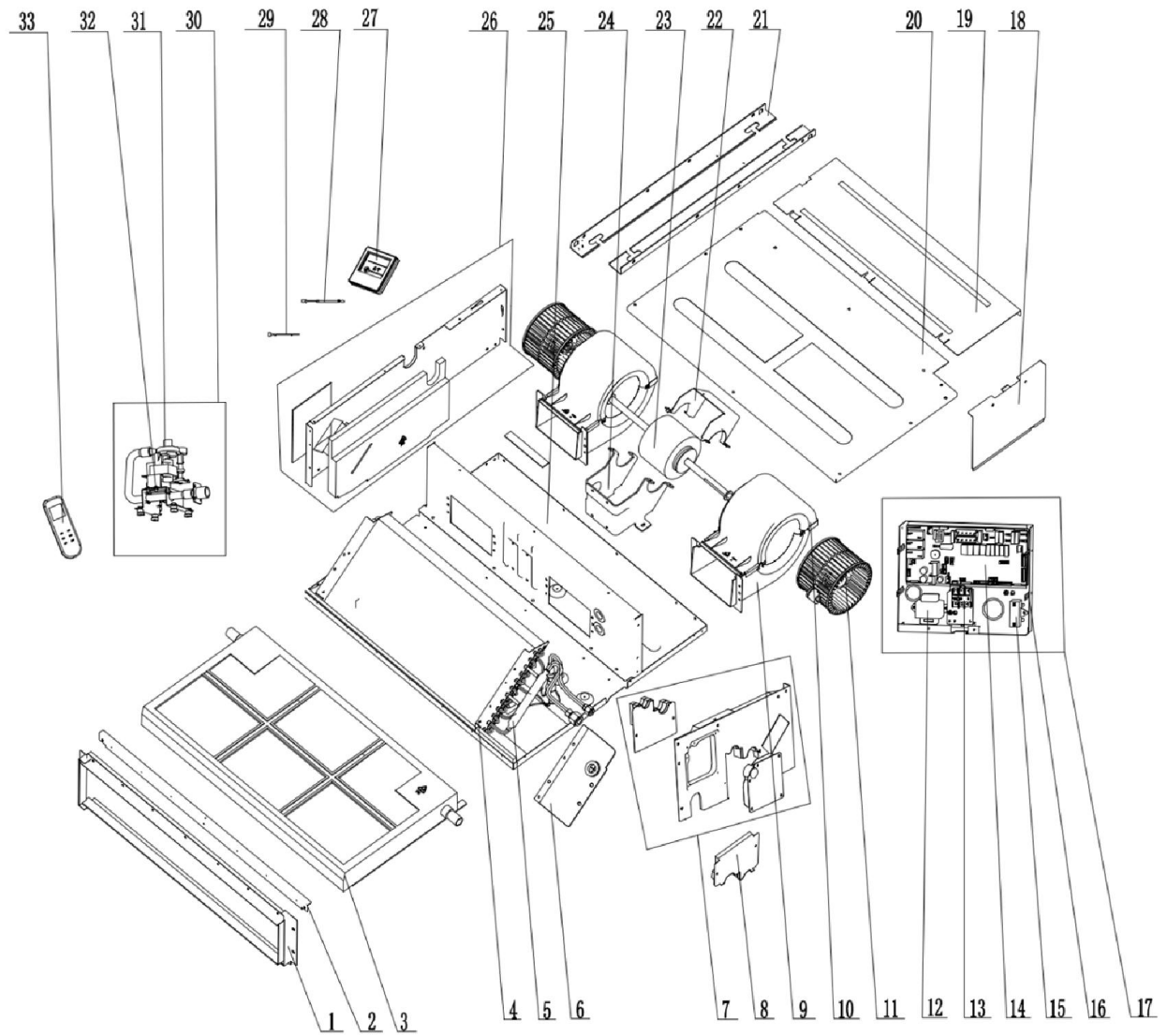

No	Description	Part Code	Note	Qty	Price Code
MODEL: MV-D12BI Duct unit					
1	Air outlet frame assy	01865216		1	AH
2	Cover of air outlet	01265298		1	AG
3	Water Tray Assy	01285332		1	AW
4	Top Cover Board Assy	01265325		1	AT
5	Evaporator Assy	011001060291		1	BE
6	Sealplate sub-assy (evaporator)	01495317		1	AH
7	Left Side Plate Assy	01315334		1	AK
8	Sealplate sub-assy (outlet)	01495316		1	AE
9	Front Volute Casing	26905205		2	AH
10	Rear Volute Casing	26905206		2	AH
11	Centrifugal Fan	10425200		2	AR
12	Transformer	4311023303		1	AM
13	Terminal Board	420001000002		1	AF
14	Main Board	30226338		1	AY
15	Capacitor CBB61S	3301074704		1	AH
16	Electric Box Sub-Assy	01395100		1	AM
17	Electric Box Assy	01395983		1	BB
18	Electric Box Cover	01424253		1	AF
19	Cover board (Fan motor)	01265300		1	AM
20	Bottom Cover Plate	01265299		1	AP
21	Supporter	01895225		2	AH
22	Bar Clasp	012133000018		2	AB
23	Fan Motor	15010100007001		1	BA
24	Motor Support	01804348		1	AK
25	Fan Motor Mounting Plate Sub-Assy	01325200007		1	AP
26	Right Side Plate Assy	01315335		1	AM
27	Display Board	300001060284_L41851		1	-
28	Ambient Temperature Sensor	39000206		1	AD
29	Temperature Sensor	390001982G		1	AD
30	Water Pump Assy	15405200082		1	BD
31	Water Level Switch	45020216		1	AQ
32	Water Pump	43130324		1	BC
33	Remote Controller	305100491_L41851		1	AT

The data are subject to change without notice.

MV-D18BI

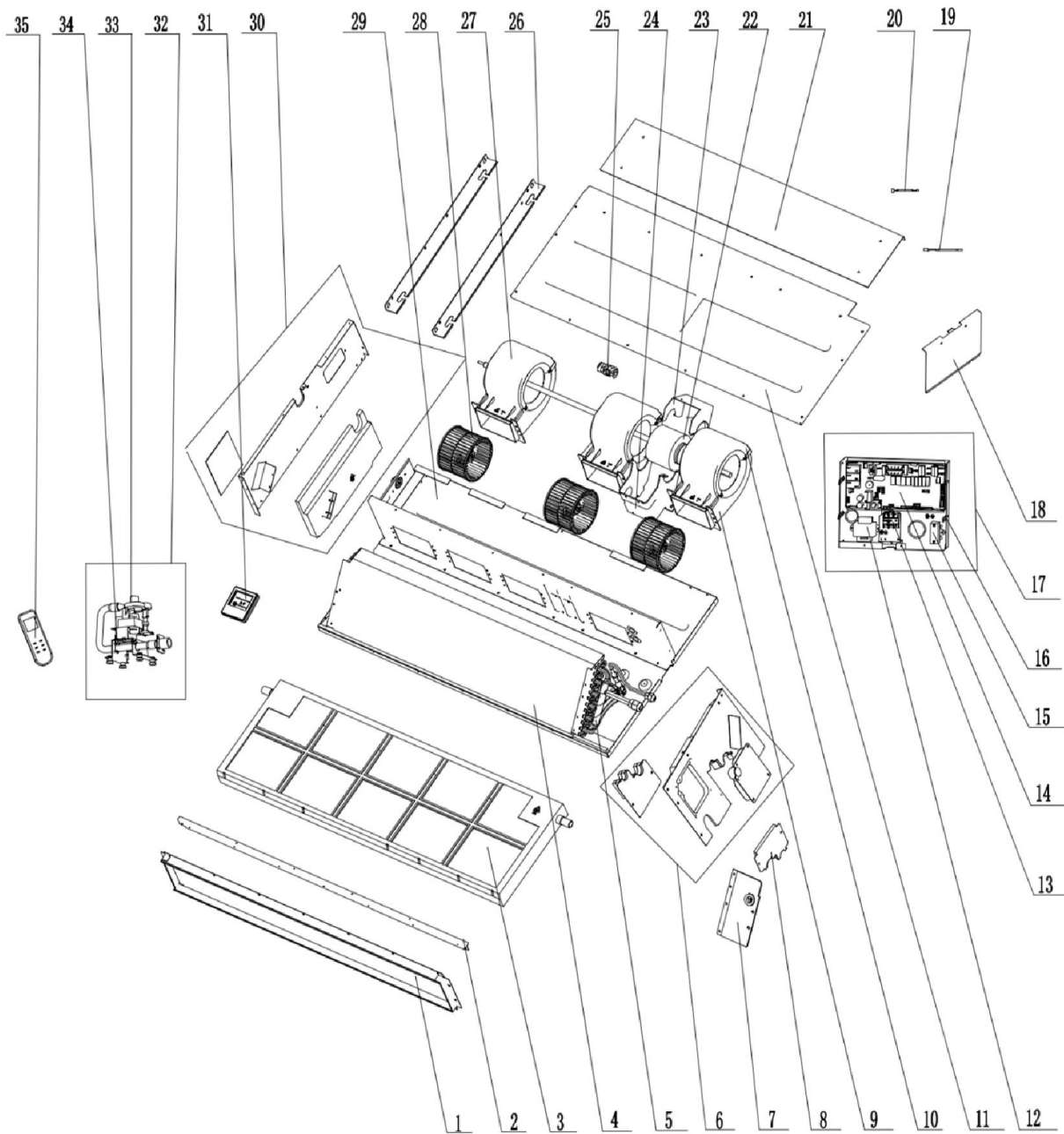

No	Description	Part Code	Note	Qty	Price Code
MODEL: MV-D18BI Duct unit					
1	Air outlet frame assy	01865217		1	AM
2	Cover of Air Outlet	01265331		1	AG
3	Water Tray Assy	01285333		1	AW
4	Evaporator Assy	011001060407		1	BE
5	Top Cover Board Assy	01265328		1	AU
6	Left Side Plate Assy	01315334		1	AK
7	Sealplate sub-assy (evaporator)	01495317		1	AH
8	Sealplate sub-assy (outlet)	01495316		1	AE
9	Front Volute Casing	26905205		3	AH
10	Rear Volute Casing	26905206		3	AH
11	Bottom Cover Plate	01265332		1	AQ
12	Transformer	4311023303		1	AM
13	Terminal Board	420001000002		1	AF
14	Main Board	30226338		1	AY
15	Capacitor CBB61S	3301074704		1	AH
16	Electric Box Sub-Assy	01395100		1	AM
17	Electric Box Assy	01395984		1	BB
18	Electric Box Cover	01424253		1	AF
19	Temperature Sensor	390001982G		1	AD
20	Ambient Temperature Sensor	39000206		1	AD
21	Cover board (Fan motor)	01265333		1	AM
22	Fan Motor	15010100007401		1	BB
23	Bar Clasp	012133000018		2	AB
24	Motor Support	01804348		1	AK
25	Joint Slack	73018731		1	AK
26	Supporter	01895225		2	AH
27	Rotary Axis Sub-Assy	73018020		1	AP
28	Centrifugal Fan	10425200		3	AR
29	Fan Motor Mounting Plate Sub-Assy	01325200006		1	AR
30	Right Side Plate Assy	01305263		1	AM
31	Display Board	300001060284_L41851		1	-
32	Water Pump Assy	15405200082		1	BD
33	Water Level Switch	45020216		1	AQ
34	Water Pump	43130324		1	BC
35	Remote Controller	305100491_L41851		1	AT

The data are subject to change without notice.

MV-D24BI

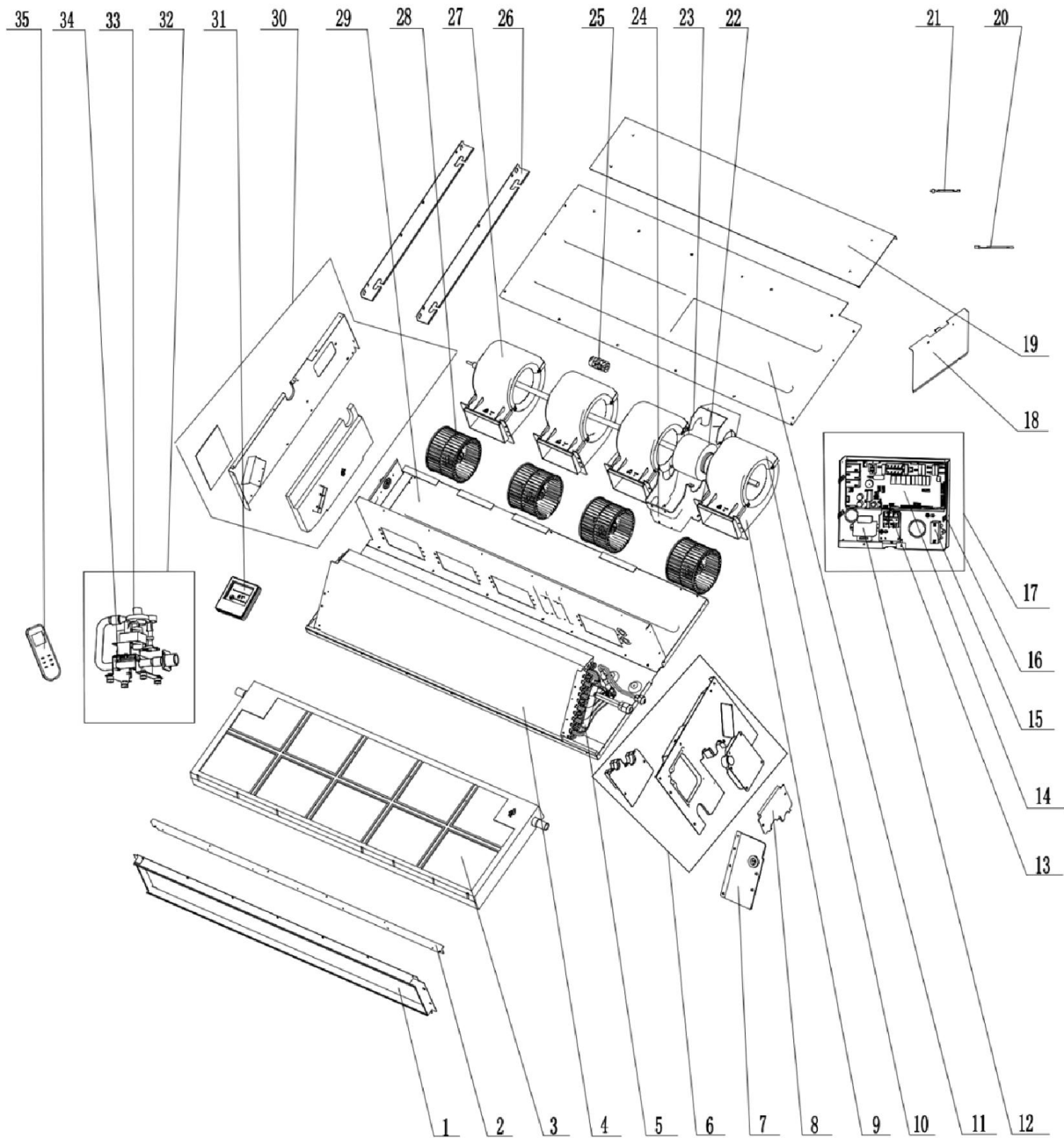

No	Description	Part Code	Note	Qty	Price Code
MODEL: MV-D24BI Duct unit					
1	Air outlet frame assy	01375224		1	AM
2	Cover of Air Outlet	01265335		1	AG
3	Water Tray Assy	01285334		1	AX
4	Evaporator Assy	011001060408		1	BE
5	Lower Cover Plate Sub-Assy	01265339		1	AW
6	Left Side Plate Assy	01315334		1	AK
7	Sealplate sub-assy (evaporator)	01495317		1	AH
8	Sealplate sub-assy (outlet)	01495316		1	AE
9	Front Volute Casing	26905205		4	AH
10	Rear Volute Casing	26905206		4	AH
11	Bottom Cover Plate	01265337		1	AR
12	Transformer	4311023303		1	AM
13	Terminal Board	420001000002		1	AF
14	Main Board	30226338		1	AY
15	Capacitor CBB61S	3301074705		1	AH
16	Electric Box Sub-Assy	01395100		1	AM
17	Electric Box Assy	100002003008		1	AZ
18	Electric Box Cover	01424253		1	AF
19	Cover board (Fan motor)	01265338		1	AM
20	Temperature Sensor	390001982G		1	AD
21	Ambient Temperature Sensor	39000206		1	AD
22	Fan Motor	150101000059		1	BB
23	Bar Clasp	012133000018		1	AB
24	Motor Support	01804348		1	AK
25	Joint Slack	73018731		1	AK
26	Supporter	01895225		2	AH
27	Rotary Axis Sub-Assy	73018000013		1	AQ
28	Centrifugal Fan	10425200		4	AR
29	Fan Motor Mounting Plate Sub-Assy	01325200005		1	AS
30	Right Side Plate Assy	01305263		1	AM
31	Display Board	300001060284_L41851		1	-
32	Water Pump Assy	15405200082		1	BD
33	Water Level Switch	45020216		1	AQ
34	Water Pump	43130324		1	BC
35	Remote Controller	305100491_L41851		1	AT

The data are subject to change without notice.

NOTE CONCERNING PROTECTION OF ENVIRONMENT



This product must not be disposed of via normal household waste after its service life, but must be taken to a collection station for the recycling of electrical and electronic devices. The symbol on the product, the operating instructions or the packaging indicate such disposal procedures. The materials are recyclable in accordance with their respective symbols. By means of re-use, material recycling or any other form of recycling old appliances you are making an important contribution to the protection of our environment. Please ask your local council where your nearest disposal station is located.

INFORMATION CONCERNING USED REFRIGERANT MEDIUM

This unit is containing fluorinated gases included in the Kyoto protocol. The maintenance and the liquidation must be carried out by qualified personnel.

Type of refrigerant: R32

The quantity of the refrigerant: please see the unit label.

The value GWP: 675 (1 kg R32 = 0,675 t CO₂ eq)

GWP = Global Warming Potential



Appliance filled with flammable gas R32.

In case of quality problem or other please contact your local supplier or authorized service center.

Emergency number: 112

PRODUCER

SINCLAIR CORPORATION Ltd.

1-4 Argyll St.

London W1F 7LD

Great Britain

www.sinclair-world.com

This product was manufactured in China (Made in China).

REPRESENTATIVE

SINCLAIR EUROPE spol. s r.o.

Purkynova 45

612 00 Brno

Czech Republic

TECHNICAL SUPPORT

NEPA spol. s r.o.

Purkynova 45

612 00 Brno

Czech Republic

Tel.: +420 800 100 285

Fax: +420 541 590 124

www.sinclair-solutions.com

info@sinclair-solutions.com

