

SERVICE MANUAL

MULTI VARIABLE SERIES FLOOR-CEILING

MV-FxxBI



“Original instructions”

IMPORTANT NOTE:

Read this manual carefully before installing or operating your new air conditioning unit. Make sure to save this manual for future reference.

Table of Contents

Part I : Technical Information	1
1. Summary	1
2. Specifications	2
3. Outline Dimension Diagram	5
4. Refrigerant System Diagram	6
5. Electrical Part	7
5.1 Wiring Diagram.....	7
5.2 PCB Printed Diagram.....	8
6. Function and Control	9
6.1 Remote Controller Introduction.....	9
6.2 Brief Description of Modes and Functions.....	13
Part II : Installation and Maintenance	16
7. Indoor Unit Installation	16
8. Maintenance	26
9. Exploded View and Parts List	34
10. Removal Procedure	37

Part I : Technical Information

1. Summary

Indoor Unit

MV-F09BI
MV-F12BI
MV-F18BI

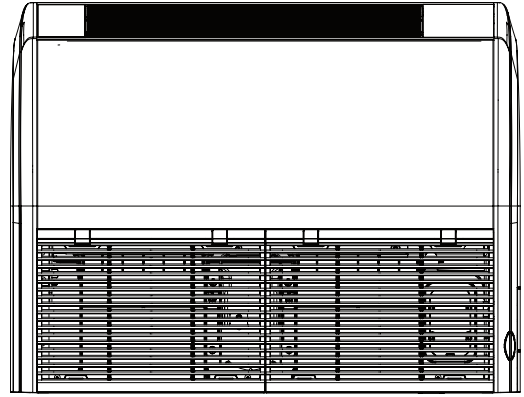

MV-F24BI

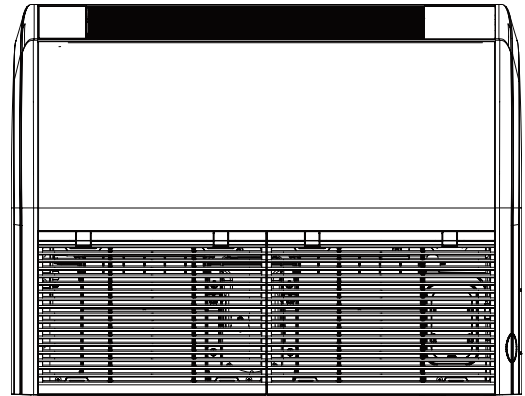

Remote Controller

YT1F(MOTO)



2. Specifications

2.1 Specification Sheet

Parameter		Unit	Value	
Model			MV-F09BI	MV-F12BI
Product Code			CN610N0130	CN610N0140
Power Supply	Rated Voltage	V~	220-240	220-240
	Rated Frequency	Hz	50	50
	Phases		1	1
Cooling Capacity		W	2600	3500
Heating Capacity		W	2700	4000
Cooling Power Input		W	40	40
Heating Power Input		W	40	40
Cooling Current Input		A	0.17	0.17
Heating Current Input		A	0.17	0.17
Air flow volume(SH/H/M/L/SL)		m ³ /h	700/610/540/420/-	700/610/540/420/-
Dehumidifying Volume		L/h	0.8	1.4
Fan Type			Centrifugal	Centrifugal
Fan Diameter-height		mm	Φ155-185	Φ155-185
Fan Motor Speed		rpm	790/690/610/480	790/690/610/480
Fan Motor Power Output		W	15	15
Fan Motor Power Input		W	38	38
Motor Full Load Amp(FLA)		A	0.28	0.28
Fan Motor Capacitor		μF	1	1
Evaporator Material			Aluminum fin-copper tube	Aluminum fin-copper tube
Evaporator Pipe Diameter		mm	Φ5	Φ5
Evaporator Number of Rows-Fin Pitch		mm	2-1.3	2-1.3
Evaporator Length(L)XHeight(H)XWidth(W)		mm	577X304X22.8	577X304X22.8
Fuse Current		A	5	5
Sound Pressure Level(SH/H/M/L/SL)		dB (A)	38/35/30/26/-	38/35/30/26/-
Sound Power Level(SH/H/M/L/SL)		dB (A)	52/49/44/40/-	52/49/44/40/-
Dimension of Outline(LXWXH)		mm	870X235X665	870X235X665
Dimension of Carton Box(LXWXH)		mm	1030X767X285	1030X767X285
Dimension of Package(LXWXH)		mm	1033X770X300	1033X770X300
Net Weight		kg	25	25
Gross Weight		kg	30	30
Liquid pipe		mm	Φ6	Φ6
Gas Pipe(to indoor unit)		mm	Φ9.52	Φ12

The above data is subject to change without notice. Please refer to the nameplate of the unit.

Parameter		Unit	Value	
Model			MV-F18BI	MV-F24BI
Product Code			CN610N0150	CN610N0160
Power Supply	Rated Voltage	V~	220-240	220-240
	Rated Frequency	Hz	50	50
	Phases		1	1
Cooling Capacity		W	4500	7100
Heating Capacity		W	5000	8000
Cooling Power Input		W	40	60
Heating Power Input		W	40	60
Cooling Current Input		A	0.17	0.26
Heating Current Input		A	0.17	0.26
Air flow volume(SH/H/M/L/SL)		m ³ /h	680/590/520/410/-	950/870/800/720/-
Dehumidifying Volume		L/h	1.8	2.5
Fan Type			Centrifugal	Centrifugal
Fan Diameter-height		mm	Φ155-185	Φ155-185
Fan Motor Speed		rpm	790/690/610/480	760/700/640/580
Fan Motor Power Output		W	15	20
Fan Motor Power Input		W	38	60
Motor Full Load Amp(FLA)		A	0.28	0.3
Fan Motor Capacitor		μF	1	2
Evaporator Material			Aluminum fin-copper tube	Aluminum fin-copper tube
Evaporator Pipe Diameter		mm	Φ5	Φ5
Evaporator Number of Rows-Fin Pitch		mm	3-1.4	3-1.4
Evaporator Length(L)XHeight(H)XWidth(W)		mm	577X304X34.2	905X304X34.2
Fuse Current		A	5	5
Sound Pressure Level(SH/H/M/L/SL)		dB (A)	38/35/30/26/-	38/35/30/26/-
Sound Power Level(SH/H/M/L/SL)		dB (A)	52/49/44/40/-	52/49/44/41/-
Dimension of Outline(LXWXH)		mm	870X235X665	1200X235X665
Dimension of Carton Box(LXWXH)		mm	1030X767X285	1360X767X285
Dimension of Package(LXWXH)		mm	1033X770X300	1363X770X300
Net Weight		kg	25.5	33
Gross Weight		kg	30.5	40
Liquid pipe		mm	Φ6	Φ9.52
Gas Pipe(to indoor unit)		mm	Φ12	Φ16

The above data is subject to change without notice. Please refer to the nameplate of the unit.

Note: Nominal capacities are based on the follow conditions.

Mode		Indoor °C(°F)	Outdoor °C(°F)
Cooling		DB:27 (80.6)	DB:35(95)
		WB:19 (66.2)	WB:24(75.2)
Heating		DB:20 (68)	DB:7(44.6)
		WB:--(--)	WB:6 (42.8)
Piping Length	Duct type, Cassette type\ Floor ceiling type	5m	

The air volume is measured at the relevant standard external static pressure.

Noise is tested in the semianechoic room, so it should be slightly higher in the actual operation due to environmental change.

3. Outline Dimension Diagram

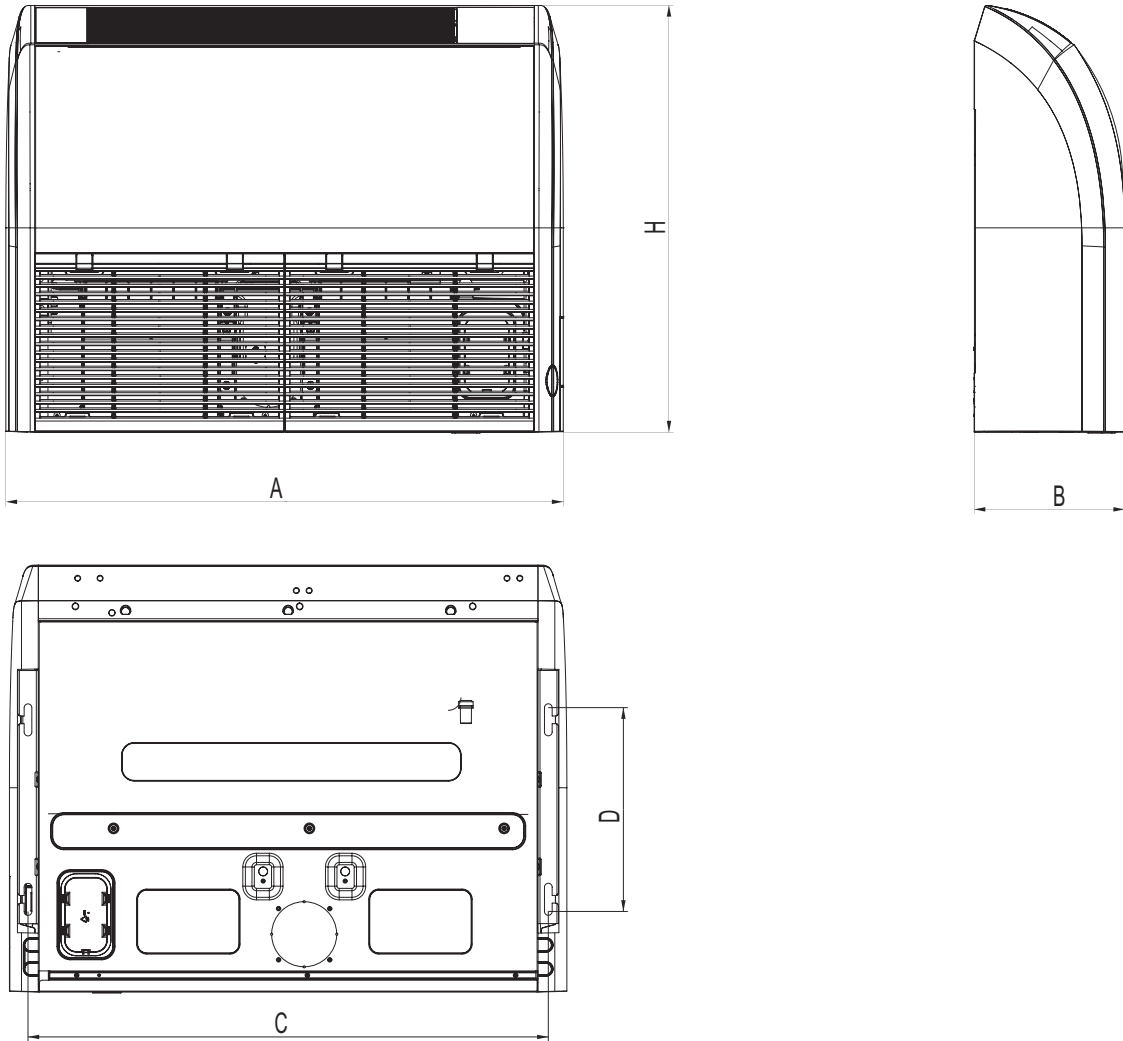

Unit:mm

Model	A	B	C	D	H
09/12/18K	870	235	812	318	665
24K	1200	235	1142	318	665

4. Refrigerant System Diagram

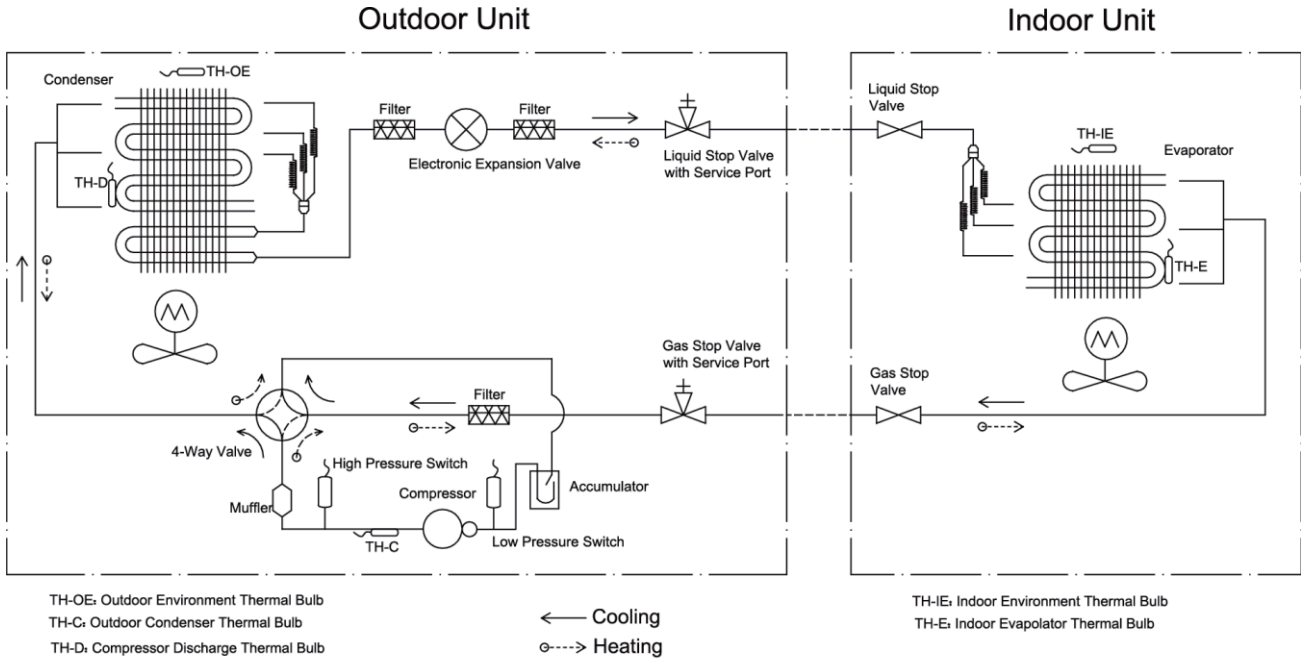

5. Electrical Part

5.1 Wiring Diagram

• Instruction

Symbol	Symbol Color	Symbol	Symbol Color	Symbol	Name
WH	White	GN	Green	CAP	Jumper cap
YE	Yellow	BN	Brown	COMP	Compressor
RD	Red	BU	Blue		Grounding wire
YEGN	Yellow/Green	BK	Black	/	/
VT	Violet	OG	Orange	/	/

Note: Jumper cap is used to determine fan speed and the swing angle of horizontal lover for this model.

• Indoor Unit

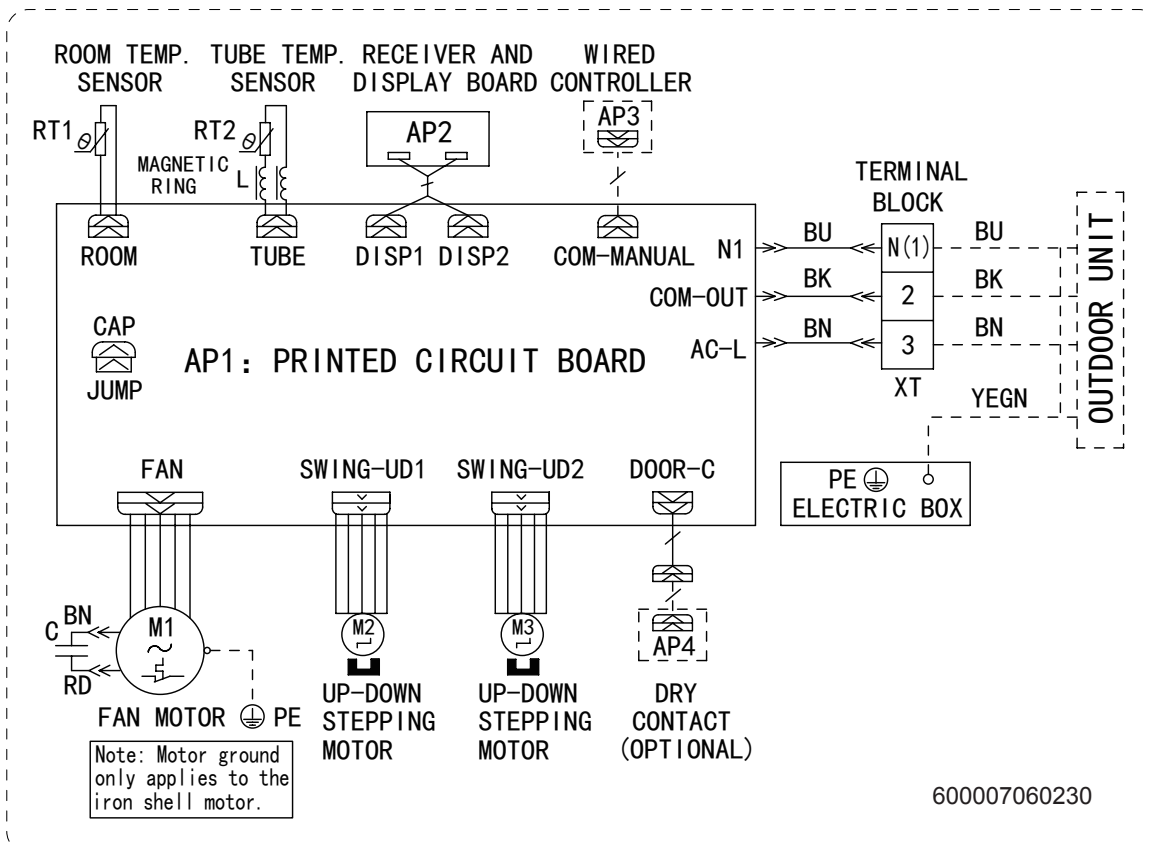

These circuit diagrams are subject to change without notice, please refer to the one supplied with the unit.

5.2 PCB Printed Diagram

● Top view

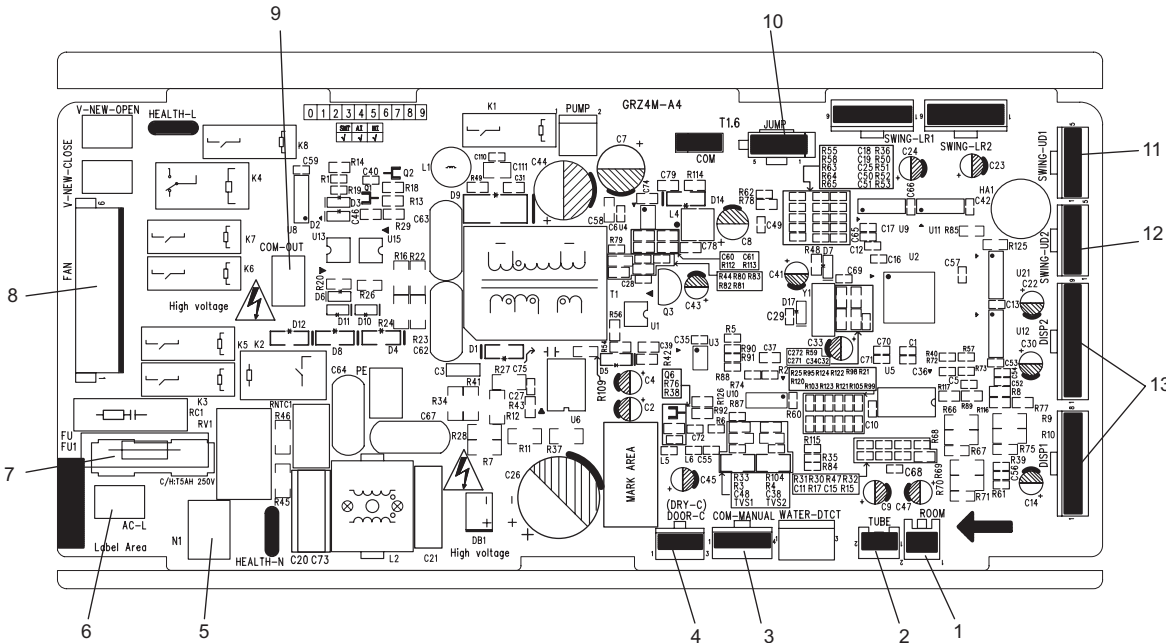

No.	Name
1	Ambient temperature sensor
2	Tube temperature sensor
3	Wired controller terminal
4	Terminal of gateway control needle stand
5	Neutral wire terminal
6	Live wire terminal
7	Fuse
8	Motor terminal
9	Connection wire terminal for indoor unit and outdoor unit
10	Jumper cap terminal
11	Up&down swing terminal 1
12	Up&down swing terminal 2
13	Terminal of display needle stand

● Bottom view

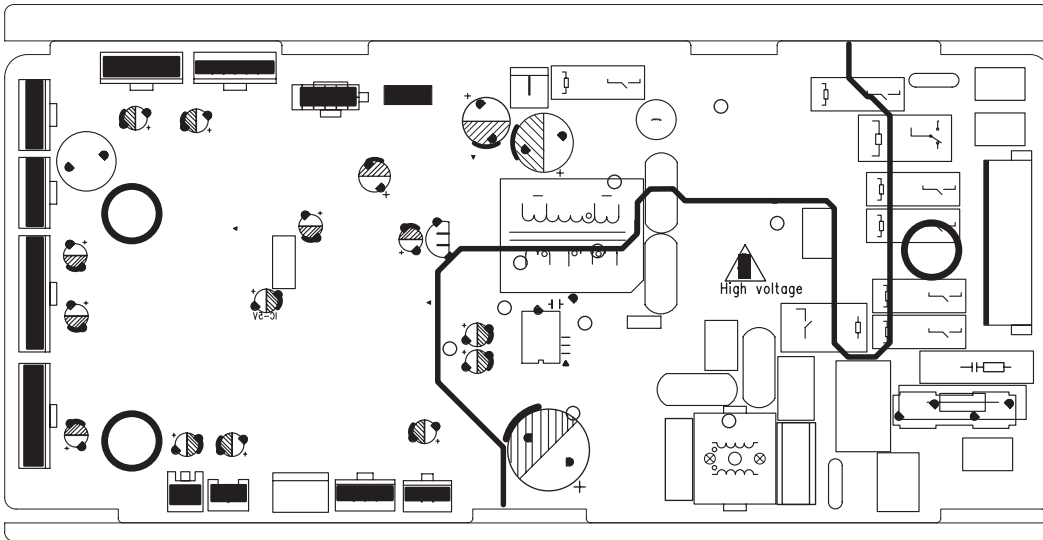

6. Function and Control

6.1 Remote Controller Introduction

Buttons on Remote Controller

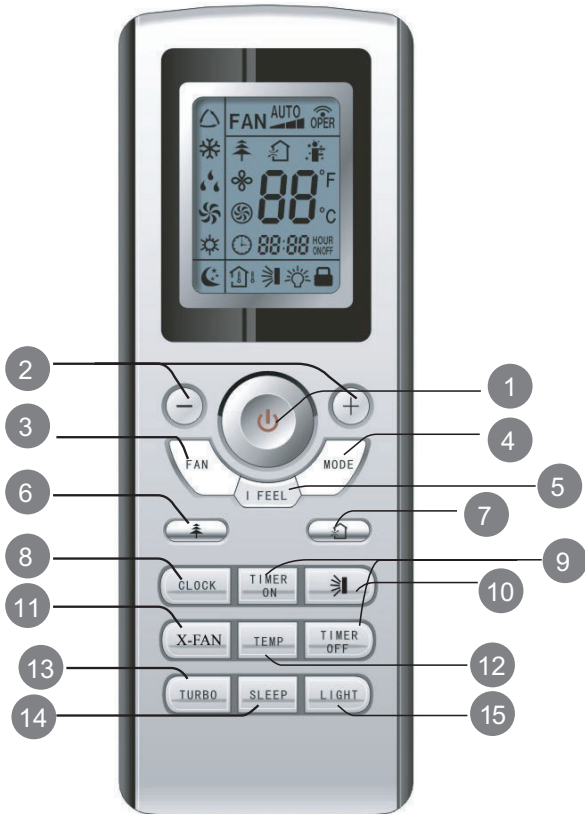

- 1 ON/OFF button
- 2 +/- button
- 3 FAN button
- 4 MODE button
- 5 I FEEL button
- 6 button
- 7 button
- 8 CLOCK button
- 9 TIMER ON/TIMER OFF button
- 10 button
- 11 X-FAN button
(Note:X-FAN is the same with BLOW)
- 12 TEMP button
- 13 TURBO button
- 14 SLEEP button
- 15 LIGHT button

Introduction for Icons on Display Screen

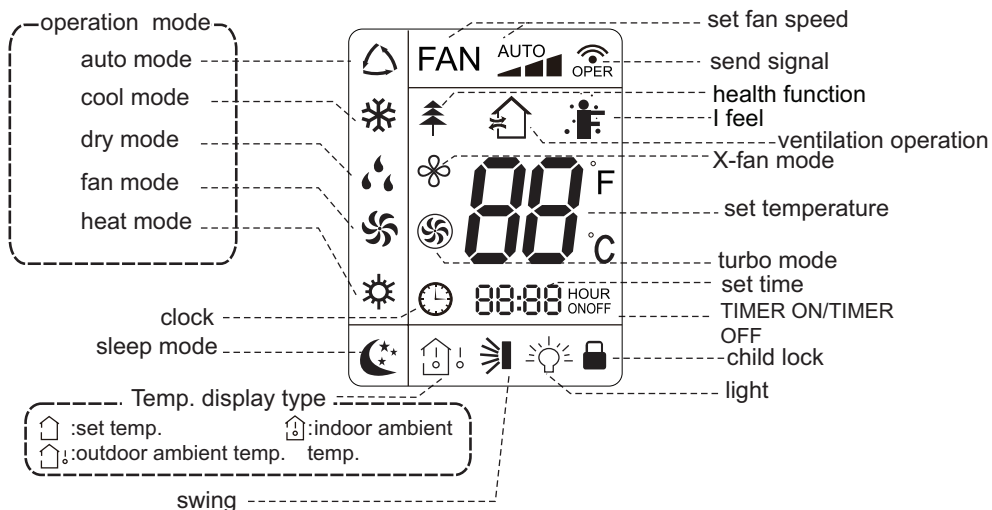

Introduction for Buttons on Remote Controller

Note:

This is a general use remote controller, it could be used for the air conditioners with multifunction; For some function, which the model don't have, if press the corresponding button on the remote controller that the unit will keep the original running status.

After putting through the power, the air conditioner will give out a sound. Operation indicator "U" is ON (red indicator). After that, you can operate the air conditioner by using remote controller.



1. ON/OFF button

Pressing this button can turn on or turn off the air conditioner. After turning on the air conditioner, operation indicator "U" on indoor unit's display is ON (green indicator. The colour is different for different models), and indoor unit will give out a sound.

2. "+" or "-" button

- Press "+" or "-" button once increase or decrease set temperature 1°C. Holding "+" or "-" button, 2s later, set temperature on remote controller will change quickly. On releasing button after setting is finished, temperature indicator on indoor unit will change accordingly. (Temperature can't be adjusted under auto mode)
- When setting TIMER ON, TIMER OFF or CLOCK, press "+" or "-" button to adjust time. (Refer to CLOCK, TIMER ON, TIMER OFF buttons) When setting TIMER ON, TIMER OFF or CLOCK, press "+" or "-" button to adjust time. (Refer to CLOCK, TIMER ON, TIMER OFF buttons)









3. FAN button

Pressing this button can set fan speed circularly as: auto (AUTO), low() ,medium() ,high() .

4. MODE button

Press this button to select your required operation mode.



- When selecting auto mode, air conditioner will operate automatically according to exfactory setting. Set temperature can't be adjusted and will not be displayed as well. Press "FAN" button can adjust fan speed. Press "  " button can adjust fan blowing angle.
- After selecting cool mode, air conditioner will operate under cool mode. Cool indicator "  " on indoor unit is ON. Press "+" or "-" button to adjust set temperature. Press "FAN" button to adjust fan speed. Press "  " button to adjust fan blowing angle.
- When selecting dry mode, the air conditioner operates at low speed under dry mode. Dry indicator "  " on indoor unit is ON. Under dry mode, fan speed can't be adjusted. Press "  " button to adjust fan blowing angle.
- When selecting fan mode, the air conditioner will only blow fan, no cooling and no heating. all indicators are OFF. Press "FAN" button to adjust fan speed. Press "  " button to adjust fan blowing angle.
- When selecting heating mode, the air conditioner operates under heat mode. Heat indicator "  " on indoor unit is ON. Press "+" or "-" button to adjust set temperature, Press "FAN" button to adjust fan speed. Press "  " button to adjust fan blowing angle. (Cooling only unit won't receive heating mode signal. If setting heat mode with remote controller, press ON/OFF button can't start up the unit).

Note:

- For preventing cold air, after starting up heating mode, indoor unit will delay 1~5 minutes to blow air (actual delay time is depend on indoor ambient temperature).
- Set temperature range from remote controller: 16~30°C ; Fan speed: auto, low speed, medium speed, high speed.

5. I FEEL button

Press this button to turn on I FEEL function. The unit automatically adjust temperature according to the sensed temperature. Press this button again to cancel I FEEL function.



6. button

Press this button to set HEALTH function ON or OFF. After the unit is turned on, it defaults to HEALTH function ON.

7. button (Only available for some models)

Press this button to select AIR function ON or OFF.

8. CLOCK button



Press this button to set clock time. "  " icon on remote controller will blink. Press "+" or "-" button within 5s to set clock time. Each pressing of "+" or "-" button, clock time will increase or decrease 1 minute. If hold "+" or "-" button, 2s later, time will change quickly. Release this button when reaching your required time. Press "CLOCK" button to confirm the time. "  " icon stops blinking.

Note:

- Clock time adopts 24-hour mode.
- The interval between two operation can't exceeds 5s. Otherwise, remote controller will quit setting status. Operation for TIMER ON/ TIMER OFF is the same.



9. TIMER ON/TIMER OFF button

- TIMER ON button

"TIMER ON" button can set the time for timer on. After pressing this button, "  " icon disappears and the word "ON" on remote controller blinks. Press "+" or "-" button to adjust TIMER ON setting. After each pressing "+" or "-" button, TIMER ON setting will increase or decrease 1min. Hold "+" or "-" button, 2s later, the time will change quickly until reaching your required time. Press "TIMER ON" to confirm it. The word "ON" will stop blinking. "  " icon resumes displaying.

Cancel TIMER ON: Under the condition that TIMER ON is started up, press "TIMER ON" button to cancel it.

- TIMER OFF button

"TIMER OFF" button can set the time for timer off. After pressing this button, "  " icon disappears and the word "OFF" on remote controller blinks. Press "+" or "-" button to adjust TIMER OFF setting. After each pressing "+" or "-" button, TIMER OFF setting will increase or decrease 1min. Hold "+" or "-" button, 2s later, the time will change quickly until reaching your required time. Press "TIMER OFF" word "OFF" will stop blinking. "  " icon resumes displaying.

Cancel TIMER OFF. Under the condition that TIMER OFF is started up, press "TIMER OFF" button to cancel it.

Note:

- Under on and off status, you can set TIMER OFF or TIMER on simultaneously.
- Before setting TIMER ON or TIMER OFF, please adjust the clock time.

- After starting up TIMER ON or TIMER OFF, set the constant circulating valid. After that, air conditioner will be turned on or turned off according to setting time. ON/OFF button has no effect on setting. If you don't need this function, please use remote controller to cancel it.

10. Fan button

Press this button can select up&down swing angle. Fan blow angle can be selected circularly as below:

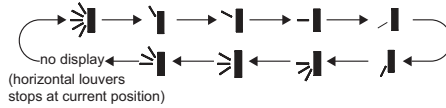

- When selecting "Fan" icon, air conditioner is blowing fan automatically. Horizontal louver will automatically swing up & down at maximum angle.
- When selecting "Up", "Down", "Left", "Right", "Up-Left", "Up-Right", "Down-Left", "Down-Right" icons, air conditioner is blowing fan at fixed position. Horizontal louver will stop at the fixed position.
- When selecting "Fan" icon with a directional arrow, air conditioner is blowing fan at fixed angle. Horizontal louver will send air at the fixed angle.
- Hold "Fan" button above 2s to set your required swing angle. When reaching your required angle, release the button.

Note:
 "Fan" icon may not be available. When air conditioner receives this signal, the air conditioner will blow fan automatically.

11. X-FAN button

Press this button under cool and dry mode to start up x-fan function, and "X-Fan" icon on remote controller will be displayed. Press this button again to cancel x-fan function, and "X-Fan" icon will disappear.

12. TEMP button

By pressing this button, you can see indoor set temperature, indoor ambient temperature or outdoor ambient temperature on indoor unit's display. The setting on remote controller is selected circularly as below:

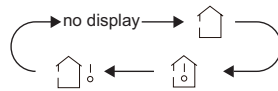

- When selecting "Set Temp" icon or no display with remote controller, temperature indicator on indoor unit displays set temperature;
- When selecting "Indoor Temp" icon with remote controller, temperature indicator on indoor unit displays indoor ambient temperature;
- When selecting "Outdoor Temp" icon with remote controller, temperature indicator on indoor unit displays outdoor ambient temperature.

Note:
 • Outdoor temperature display is not available for some models. At that time, indoor unit receives "Outdoor Temp" signal, while it displays indoor set temperature.
 • It's defaulted to display set temperature when turning on the unit. There is no display in the remote controller.
 • Only for the models whose indoor unit has dual-8 display

13. TURBO button

Under COOL or HEAT mode, press this button to turn to quick COOL or quick HEAT mode. "Turbo" icon is displayed on remote controller. Press this button again to exit turbo function and "Turbo" icon will disappear.

14. SLEEP button

Under COOL, HEAT mode, press this button to start up sleep function. "Sleep" icon is displayed on remote controller. Press this button again to cancel sleep function and "Sleep" icon will disappear.

15. LIGHT button

Pressing this button to turn off display light on indoor unit. "Light Off" icon on remote controller disappears. Press this button again to turn on display light. "Light On" icon is displayed.

Function Introduction for Combination Buttons

Child lock function:

Press "+" and "-" simultaneously to turn on or turn off child lock function. When child lock function is on, "Child Lock" icon is displayed on remote controller. If you operate the remote controller, it won't send signal.

Temperature display switchover function:

Under OFF status, press "-" and "MODE" buttons simultaneously to switch temperature display between °C and °F.

Operation Guide

1. After putting through the power, press "ON/OFF" button on remote controller to turn on the air conditioner.
2. Press "MODE" button to select your required mode: AUTO, COOL, DRY, FAN, HEAT.
3. Press "+" or "-" button to set your required temperature. (Temperature can't be adjusted under auto mode).
4. Press "FAN" button to set your required fan speed: auto, low, medium and high speed.
5. Press "Fan" button to select fan blowing angle.

Replacement of Batteries in Remote Controller

1. Press the back side of remote controller marked with "OPEN" as shown in the fig, and then push out the cover of battery box along the arrow direction.
2. Replace two 7# (AAA 1.5V) dry batteries, and make sure the position of "+" polar and "-" polar are correct.
3. Reinstall the cover of battery box.

Note:

- During operation, point the remote control signal sender at the receiving window on indoor unit.
- The distance between signal sender and receiving window should be no more than 8m, and there should be no obstacles between them.
- Signal may be interfered easily in the room where there is fluorescent lamp or wireless telephone; remote controller should be close to indoor unit during operation.
- Replace new batteries of the same model when replacement is required.
- When you don't use remote controller for a long time, please take out the batteries.
- If the display on remote controller is fuzzy or there's no display, please replace batteries.

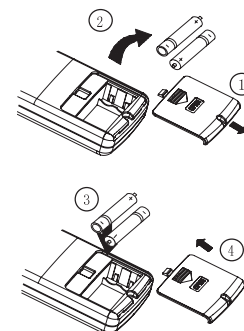

Sketch map for replacing batteries

6.2 Brief Description of Modes and Functions

1. Basic function of system

(1) Cooling mode

- (1) Under this mode, fan and swing operates at setting status. Temperature setting range is 16~30°C.
- (2) During malfunction of outdoor unit or the unit is stopped because of protection, indoor unit keeps original operation status.

(2) Drying mode

- (1) Under this mode, fan operates at low speed and swing operates at setting status. Temperature setting range is 16~30°C.
- (2) During malfunction of outdoor unit or the unit is stopped because of protection, indoor unit keeps original operation status.
- (3) Protection status is same as that under cooling mode.
- (4) Sleep function is not available for drying mode.

(3) Heating mode

- (1) Under this mode, Temperature setting range is 16~30°C.
- (2) Working condition and process for heating mode:

When turn on the unit under heating mode, indoor unit enters into cold air prevention status. When the unit is stopped or at OFF status, and indoor unit has been started up just now, the unit enters into residual heat-blowing status.

(4) Working method for AUTO mode:

1. Working condition and process for AUTO mode:

a. Under AUTO mode, standard heating $T_{\text{preset}}=20^{\circ}\text{C}$ and standard cooling $T_{\text{preset}}=25^{\circ}\text{C}$. The unit will switch mode automatically according to ambient temperature.

2. Protection function

- a. During cooling operation, protection function is same as that under cooling mode.
- b. During heating operation, protection function is same as that under heating mode.

3. Display: Set temperature is the set value under each condition. Ambient temperature is ($T_{\text{amb.}}-T_{\text{compensation}}$) for heat pump unit and $T_{\text{amb.}}$ for cooling only unit.

4. If there's I feel function, $T_{\text{compensation}}$ is 0. Others are same as above.

(5) Fan mode

Under this mode, indoor fan operates at set fan speed. Compressor, outdoor fan, 4-way valve and electric heating tube stop operation. Indoor fan can select to operate at high, medium, low or auto fan speed. Temperature setting range is 16~30°C.

2. Other control

(1) Buzzer

Upon energization or availablely operating the unit or remote controller, the buzzer will give out a beep.

(2) Auto fan

Heating mode: During auto heating mode or normal heating mode, auto fan speed will adjust the fan speed automatically according to ambient temperature and set temperature.

(3) Sleep

After setting sleep function for a period of time, system will adjust set temperature automatically.

(4) Timer function:

General timer and clock timer functions are compatible by equipping remote controller with different functions.

(5) Memory function

memorize compensation temperature, off-peak energization value.

Memory content: mode, up&down swing, light, set temperature, set fan speed, general timer (clock timer can't be memorized).

After power recovery, the unit will be turned on automatically according to memory content.

(6) Health function (Health function is not available for this unit.)

During operation of indoor fan, set health function by remote controller. Turn off the unit will also turn off health function.

Turn on the unit by pressing auto button, and the health is defaulted ON.

(7) I feel control mode

After controller received I feel control signal and ambient temperature sent by remote controller, controller will work according to the ambient temperature sent by remote controller.

(8) Compulsory defrosting function

(1) Start up compulsory defrosting function

Under ON status, set heating mode with remote controller and adjust the temperature to 16°C. Press “+, -, +, -, +,-” button successively within 5s and the complete unit will enter into compulsory defrosting status. Meanwhile, heating indicator on indoor unit will ON 10s and OFF 0.5s successively. (Note: If complete unit has malfunction or stops operation due to protection, compulsory defrosting function can be started up after malfunction or protection is resumed.

(2) Exit compulsory defrosting mode

After compulsory defrosting is started up, the complete unit will exit defrosting operation according to the actual defrosting result, and the complete unit will resume normal heating operation.

(9) Refrigerant recovery function:

(1) Enter refrigerant recycling function

Within 5min after energizing (unit ON or OFF status is ok), continuously press LIGHT button for 3 times within 3s to enter refrigerant recycling mode; Fo is displayed and refrigerant recycling function is started. At this moment, the maintenance people closes liquid valve. After 5min, stick the thimble of maintenance valve with a tool. If there is no refrigerant spraying out, close the gas valve immediately and then turn off the unit to remove the connection pipe.

(2) Exit refrigerant recycling function

After entering refrigerant recycling mode, when receive any remote control signal or enter refrigerant recycling mode for 25min, the unit will exit refrigerant recycling mode automatically. If the unit is in standby mode before refrigerant recycling, it will be still in standby mode after finishing refrigerant recycling; if the unit is in ON status before refrigerant recycling, it will still run in original operation mode.

(10) Ambient temperature display control mode

1. When user set the remote controller to display set temperature (corresponding remote control code: 01), current set temperature will be displayed.

2. Only when remote control signal is switched to indoor ambient temperature display status (corresponding remote control code: 10) from other display status (corresponding remote control code: 00, 01, 11), controller will display indoor ambient temperature for 3s and then turn back to display set temperature.

Under this mode, indoor fan operates at set fan speed. Compressor, outdoor fan, 4-way valve and electric heating tube stop operation. Indoor fan can select to operate at high, medium, low or auto fan speed. Temperature setting range is 16~30°C.

(11) Off-peak energization function:

Adjust compressors minimum stop time. The original minimum stop time is 180s and then we change to:

The time interval between two start-ups of compressor can't be less than $180+T$ s ($0 \leq T \leq 15$). T is the variable of controller. That's to say the minimum stop time of compressor is 180s~195s. Read-in T into memory chip when refurbish the memory chip each time. After power recovery, compressor can only be started up after $180+T$ s at least.

(12) SE control mode

The unit operates at SE status.

(13) X-fan mode

When X-fan function is turned on, after turn off the unit, indoor fan will still operate at low speed for 2min and then the complete unit will be turned off. When x-fan function is turned off, after turn off the unit, the complete unit will be turned off directly.

(14) 8°C heating function

Under heating mode, you can set 8°C heating function by remote controller. The system will operate at 8°C set temperature.

(15) Turbo fan control function

Set turbo function under cooling or heating mode to enter into turbo fan speed. Press fan speed button to cancel turbo wind. No turbo function under auto, dry or fan mode.

3. Instructions to the Error Indicating Lamps on the Panel of the Floor Ceiling Type Unit.

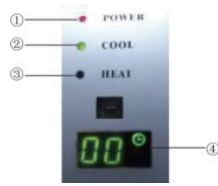

Fig.1

States of the Indicating Lamps:

①. Indicating Lamp of "POWER":

The indicating lamp will shine when power on, while it will go out when power off.

②. Indicating Lamp of "COOL" :

The indicating lamp will shine when "COOL" is activated, while it will go out when "COOL" is deactivated.

③. Indicating Lamp of "HEAT":

The indicating lamp will shine when "HEAT" is activated, while it will go out when "HEAT" is deactivated.

④. Indicating Lamp of "TIMER":

Timer indicator on indoor unit will be on when timer ON is set under off status and timer OFF is set under on status.

NOTE:

- (1) If the light of indoor unit is turned off, when operating the remote controller to send command, the display will be on, for 3s and then off.
- (2) When the wired controller is connected, the indoor unit display is invalid and the unit won't receive the remote control command.

Part II : Installation and Maintenance

7. Indoor Unit Installation

7.1 Installation of Floor Ceiling Type

7.1.1 Before Installation

After receiving the machine, please check for any transport damage. If finding any surface or internal damage, please immediately report to the transport company or equipment company in writing.

After receiving the machine, please check the unit and accessories in reference to the packing list. Ensure that the model is correct and the machine is in good condition. Please also check if the specification and quantity of accessory parts are correct.

Determine the correct handling route and methods, thus to avoid damaging the unit or causing possible hazard. For the sake of protection and safety, it is suggested to move the unit with the packaging box. Even though it is not permitted to do like this under special occasions, do not remove the packaging box, thus to avoid loosening or falling during handling.

Confirm if the installing foundation is solid. When this unit is to be installed on the metal section of the building, make sure that the electrical insulation must comply with applicable standards.

Ensure that the place of installation is far from the area where the inflammable or explosive substances are stored, thus to avoid possible explosion or fire due to leakage.

7.1.2 Installation Site

- (1) Install the unit at a place where is strong enough to withstand the weight of the unit.
- (2) The air inlet and outlet of the unit should never be clogged so that the airflow can reach every corner of the room.
- (3) Leave service space around the unit as required in Figure 3-1-49.

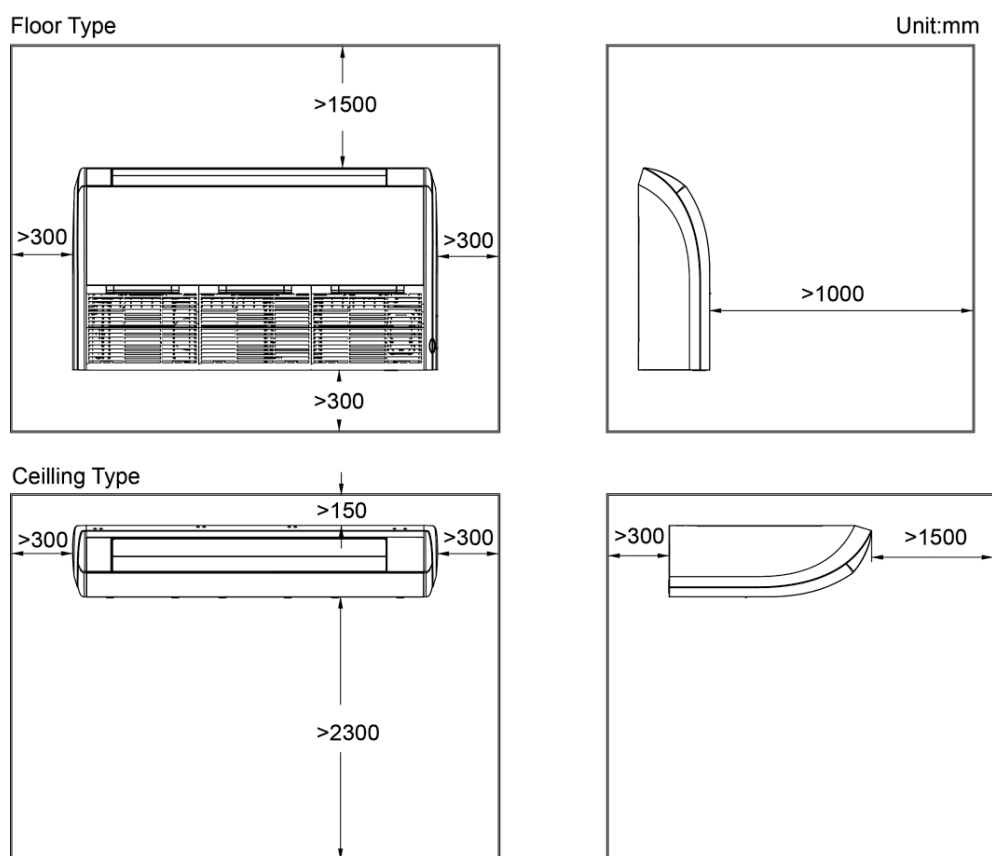

Figure 3-1-49

- (4) Install the unit where the drain pipe can be easily installed.
- (5) The space from the unit to the ceiling should be kept as much as possible so as for more

convenient service.

7.1.3 Indoor Unit Installation

- (1) Determine the location of the hanger through the paper template, and then remove the paper template.

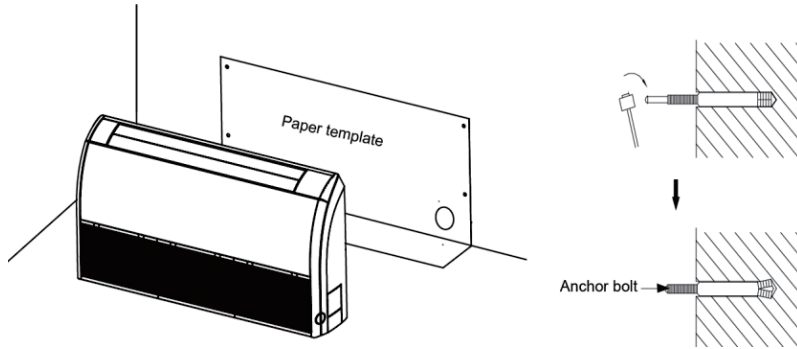

Figure 3-1-50

- (2) Insert the anchor bolts into the drilled holes, and drive the pins completely into the anchor bolts with a hammer.
- (3) Remove the right and left side panels.
- (4) Put the hanger bolt into the clasp of the indoor unit and tighten screws on the hanger to prevent the indoor unit from moving.
- (5) Adjust the height of the unit to make the drain pipe slant slightly downward so that the drainage will become much smoother.

◆ Floor type

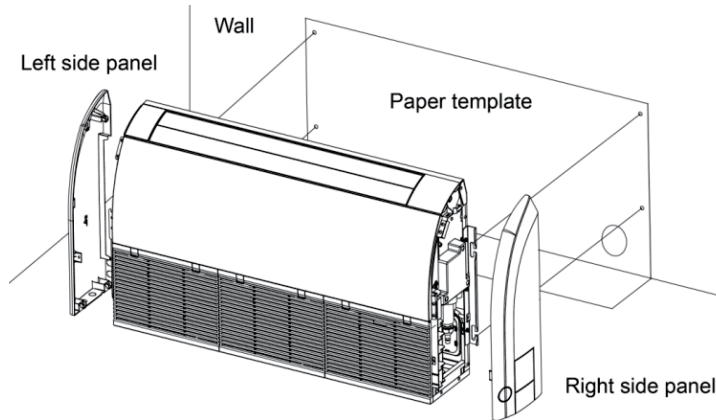
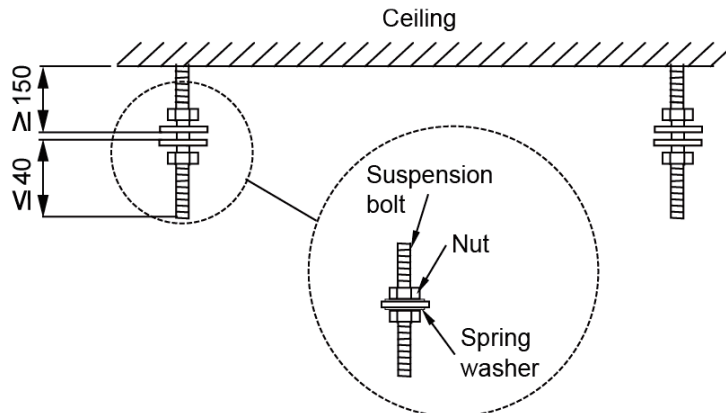

Figure 3-1-51

◆ Ceiling type



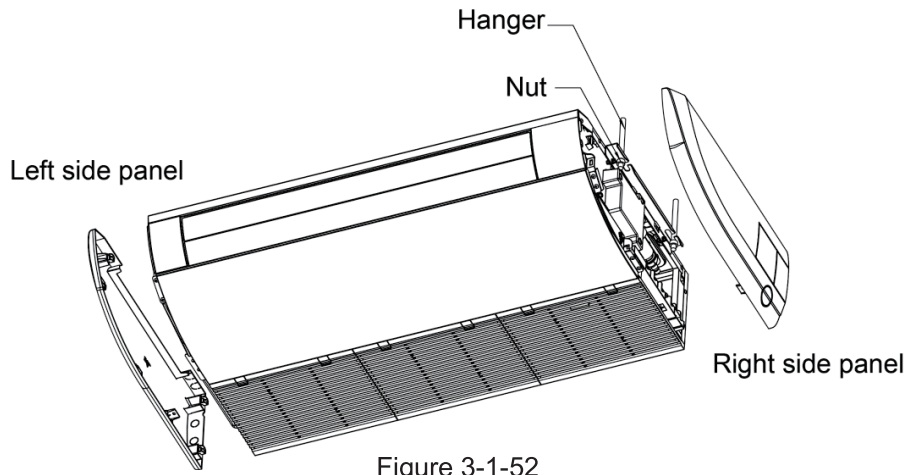
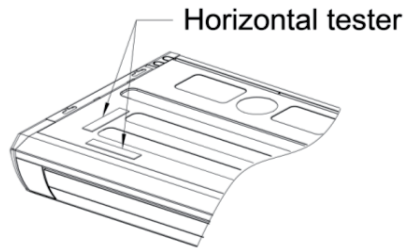

Figure 3-1-52

(6) Reinstall and tighten the right and left side panel.

7.1.4 Leveling

The water level test must be done after installing the indoor unit to make the unit is horizontal, as shown below.



7.1.5 Dimension Data

Figure 3-1-53

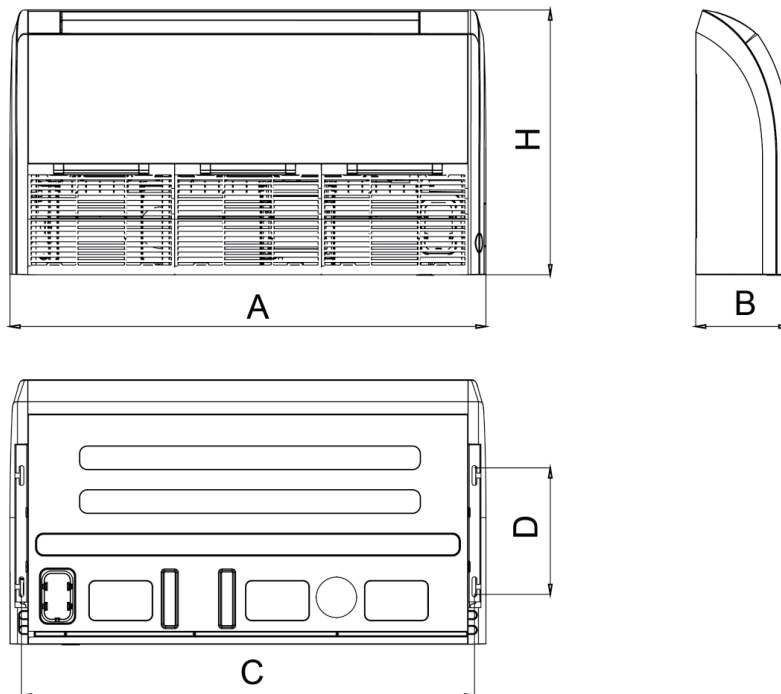

Figure 3-1-54
Table 3-1-9

Unit: mm

Model	A	B	C	D	H
09/12/18K	870	235	812	318	665
24K	1200	235	1142	318	665

7.1.6 Drain Piping Work

7.1.6.1 Precautions When Doing the Piping Work

- (1) Keep piping as short as possible and slope it downwards at a gradient of at least 1/100 so that air may not remain trapped inside the pipe.
- (2) Keep pipe size equal to or greater than that of the connecting pipe.
- (3) Install the drain piping as shown and take measures against condensation. Improperly rigged piping could lead to leaks and eventually wet furniture and belongings.

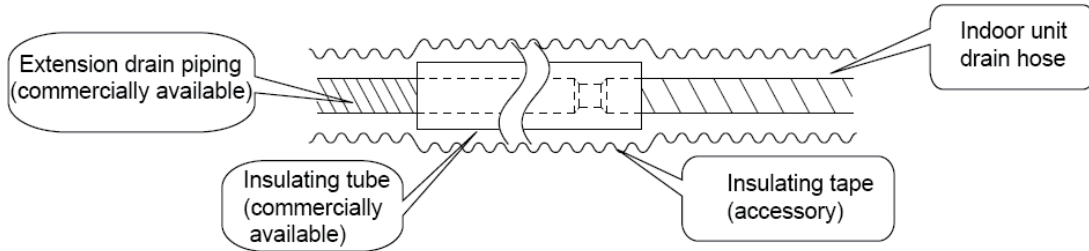

Figure 3-1-55

- (4) Connect the drain hose. (Figure 3-1-56)

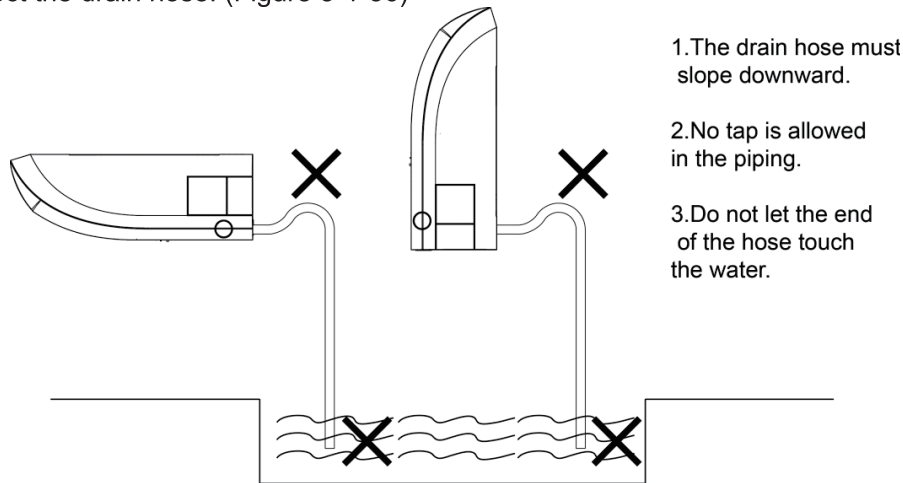

Figure 3-1-56

7.1.6.2 Installing the Drain Pipes

- (1) For determining the position of the drain hose, perform the following procedures.
- (2) Insert the drain pipe to the drain outlet of the unit and then tighten the clamp securely with tape. (Figure 3-1-57)
- (3) Connect the extension drain pipe to the drain pipe and then tighten the clamp with tape.

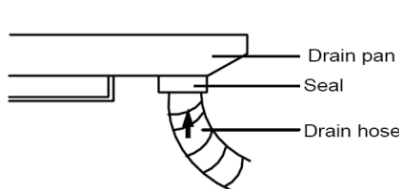

Figure 3-1-57

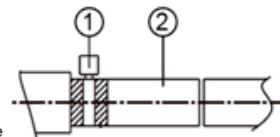

Figure 3-1-58

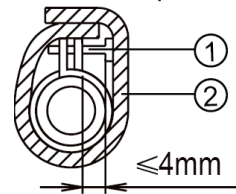

Figure 3-1-59

Tighten the clamp until the screw head is less than 4 mm from the hose. (Figure 3-1-58)

R - Metal clamp q - Drain hose.

Insulate the pipe clamp and the drain hose using heat insulation sponge. (Figure 3-1-59)

R - Metal clamp q - Insulation sponge.

- (4) When drain hose requires extension, obtain an extension hose commercially available.
- (5) After connecting the local drain hose, tape the slits of the heat insulation tube.
- (6) Connect the drain hose to the local drain pipe. Position the inter connecting wire in the same direction as the piping.

7.1.6.3 Connecting the Drain Hose

- (1) Connect the extension auxiliary pipe to the local piping.
- (2) Prepare the local piping at the connection point for the drain pipe, as shown in the installation drawings.

Note: Be sure to place the drain hose as shown in the diagram below, in a downward sloping direction.

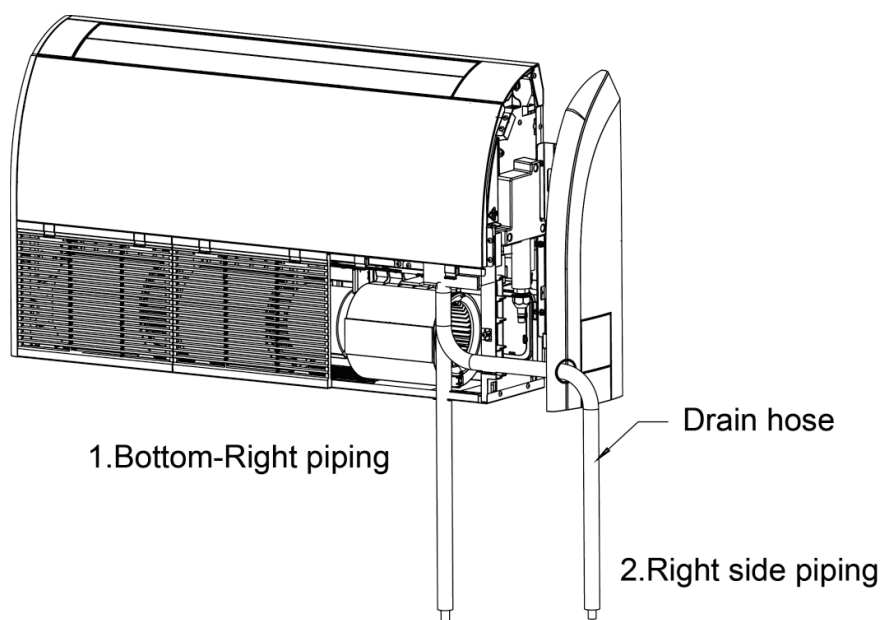

Figure 3-1-60

7.1.6.4 Testing of Drain Piping

- (1) After piping work is finished, check if drainage flows smoothly.
- (2) As shown in the figure, pour water into the drain pan from the right side to check that water flows smoothly from the drain hose.

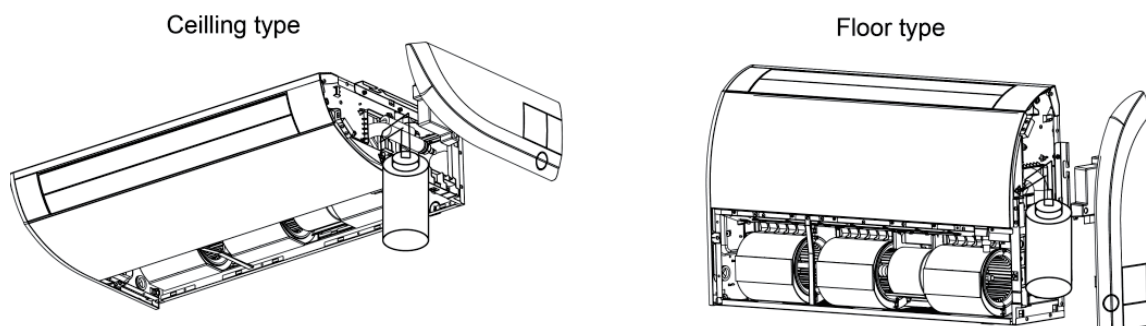



Figure 3-1-61

7.2 Electrical Wiring

7.2.1 Wiring Precautions

 WARNING!
1. Before obtaining access to terminals, all supply circuits must be disconnected.
2. The rated voltage of the unit is as shown as Table 3
3. Before turning on, verify that the voltage is within the 198-264V range (for single phase unit)
4. Always use a special branch circuit and install a special receptacle to supply power to the air conditioner.
5. The special branch circuit breaker is installed in the permanent wiring. Always use a circuit that can trip all the poles of the wiring and has an isolation distance of at least 3 mm between the contacts of each pole.
6. Perform wiring work in accordance with standards so that the air conditioner can be operated safely and positively.
7. Install a leakage special branch circuit breaker in accordance with the related laws and regulations and electric company standards.
 CAUTION!
1. The power source capacity must be the sum of the air conditioner current and the current of other electrical appliances. When the current contracted capacity is insufficient, change the contracted capacity.
2. When the voltage is low and the air conditioner is difficult to start, contact the power company to raise the voltage.

5.5.2 Electrical Wiring

(1). For solid core wiring (Fig. 26)

- 1). Cut the wire end with a wire cutter or wire-cutting pliers, then strip the insulation about 25 mm (15/16").
- 2). Using a screwdriver, remove the terminal screw(s) on the terminal board.
- 3). Using pliers, bend the solid wire to form a loop suitable for the terminal screw.
- 4). Shape the loop wire properly, place it on the terminal board and tighten securely with the terminal screw using a screwdriver.

(2). For strand wiring (Fig. 26)

- 1). Cut the wire end with a wire cutter or wire-cutting pliers, then strip the insulation about 10 mm (3/8").
- 2). Using a screwdriver, remove the terminal screw (s) on the terminal board.
- 3). Using a round terminal fastener or pliers, securely clamp a round terminal to each stripped wire end.
- 4). Position the round terminal wire, and replace and tighten the terminal screw with a screwdriver.(Fig. 27)

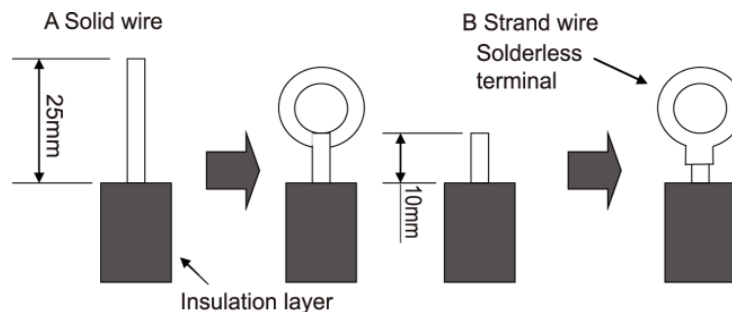

Fig. 26

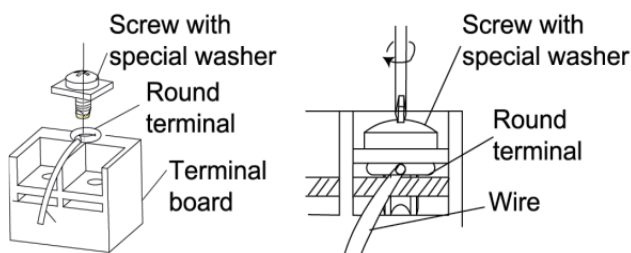

Fig. 27

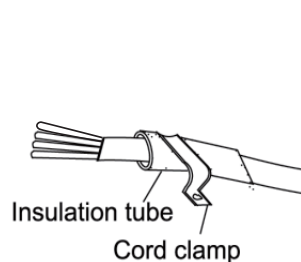



Fig. 28

(3). How to fix connection cord and power cord by cord clamp

After passing the connection cord fasten it with the cord clamp. (Fig. 28)

 WARNING!
1. Before starting work, check that power is not being supplied to the indoor unit and outdoor unit.
2. Match the terminal block numbers and connection cord colors with those of the indoor unit side.
3. Erroneous wiring may cause burning of the electric parts.
4. Connect the connection cords firmly to the terminal block. Imperfect installation may cause a fire.
5. Always fasten the outside covering of the connection cord with cord clamps. (If the insulator is not clamped, electric leakage may occur.)
6. Always connect the ground wire.

(4). Electric wiring between the indoor and outdoor units Single-phase units.

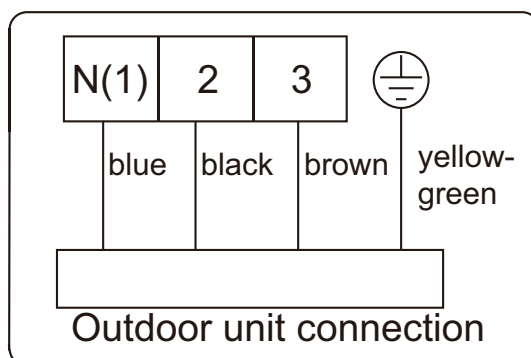

(5). Electric wiring of indoor unit side

Remove the left cover plate and the electric box cover then insert the end of the communication cord and the power cable into the terminal board.

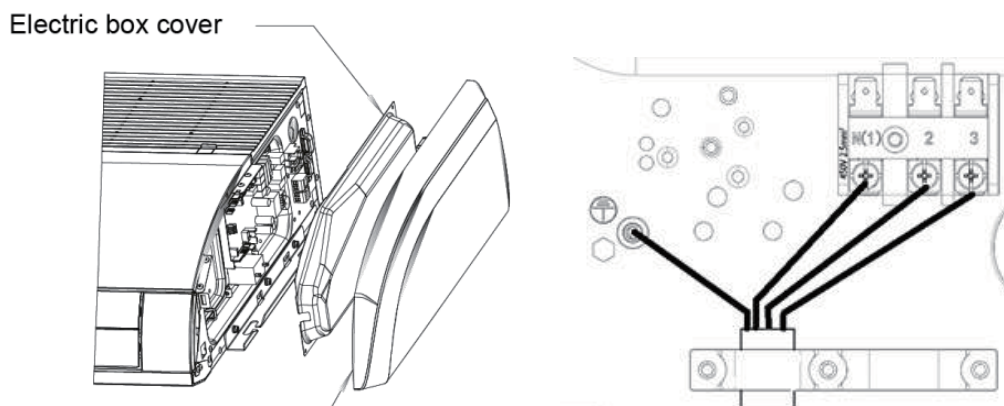

Fig. 30

Please read this operating manual carefully before operating the unit.



Appliance filled with flammable gas R32.



Before use the appliance, read the owner's manual first.



Before install the appliance, read the installation manual first.



Before repair the appliance, read the service manual first.

The figures in this manual may be different with the material objects, please refer to the material objects for reference.

● The Refrigerant

- To realize the function of the air conditioner unit, a special refrigerant circulates in the system. The used refrigerant is the fluoride R32, which is specially cleaned. The refrigerant is flammable and inodorous. Furthermore, it can lead to explosion under certain conditions. But the flammability of the refrigerant is very low. It can be ignited only by fire.
- Compared to common refrigerants, R32 is a nonpolluting refrigerant with no harm to the ozonosphere. The influence upon the greenhouse effect is also lower. R32 has got very good thermodynamic features which lead to a really high energy efficiency. The units therefore need a less filling.

WARNING:

Do not use means to accelerate the defrosting process or to clean, other than those recommended by the manufacture. Should repair be necessary, contact your nearest authorized Service Centre.

Any repairs carried out by unqualified personnel may be dangerous.

The appliance shall be stored in a room without continuously operating ignition sources. (for example: open flames, an operating gas appliance or an operating electric heater.)

Do not pierce or burn.

Appliance shall be installed, operated and stored in a room with a floor area larger than "X"m² (see table 1). (only applies to appliances that are not fixed appliances)



Appliance filled with flammable gas R32. For repairs, strictly follow manufacturer's instructions only.

Be aware that refrigerants not contain odour.

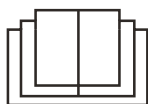
Read specialist's manual.



Safety Precautions

 WARNING!	This mark indicates procedures which, if improperly performed, might lead to the death or serious injury of the user.
 CAUTION!	This mark indicates procedures which, if improperly performed, might possibly result in personal harm to the user, or damage to property.

WARNING!

- (1). For operating the air conditioner pleasantly, install it as outlined in this installation manual.
- (2). Connect the indoor unit and outdoor unit with the room air conditioner piping and cord available from our standard parts. This installation manual describes the correct connections using the installation set available from our standard parts.
- (3). Installation work must be performed in accordance with national wiring standards by authorized personnel only.
- (4). If refrigerant leaks while work is being carried out, ventilate the area. If the refrigerant comes in contact with a flame, it produces toxic gas.
- (5). Do not power on until all installation work is complete.
- (6). During installation, make sure that the refrigerant pipe is attached firmly before you run the compressor.
Do not operate the compressor under the condition of refrigerant piping not attached properly with 2-way or 3-way valve open.
This may cause abnormal pressure in the refrigeration cycle that leads to breakage and even injury.
- (7). During the pump-down operation, make sure that the compressor is turned off before you remove the refrigerant piping.
Do not remove the connection pipe while the compressor is in operation with 2-way or 3-way valve open.
This may cause abnormal pressure in the refrigerant cycle that leads to breakage and even injury.
- (8). When installing and relocating the air conditioner do not mix gases other than the specified refrigerant (R32) to enter the refrigerant cycle.
If air or other gas enters the refrigerant cycle, the pressure inside the cycle will rise to an abnormally high value and cause breakage, injury, etc.
- (9). This appliance can be used by children aged from 8 years and above and persons with reduced physical, sensory or mental capabilities or lack of experience and knowledge if they have been given supervision or instruction concerning use of the appliance in a safe way and understand the hazards involved. Children shall not play with the appliance. Cleaning and user maintenance shall not be made by children without supervision.
- (10). If the supply cord is damaged, it must be replaced by the manufacturer, its service agent or similarly qualified persons in order to avoid a hazard.
- (11). Correct Disposal of this product
- (12). The appliance shall not be installed in the laundry.



GWP:
R32:675

This marking indicates that this product should not be disposed with other household wastes throughout the EU. To prevent possible harm to the environment or human health from uncontrolled waste disposal, recycle it responsibly to promote the sustainable reuse of material resources. To return your used device, please use the return and collection systems or contact the retailer where the product was purchased. They can take this product for environmental safe recycling.

Installation Dimension Diagram

Indoor

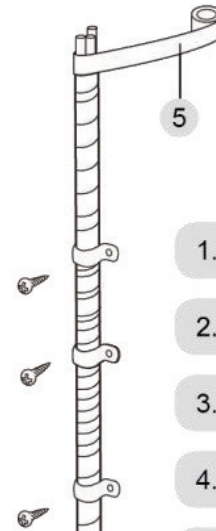
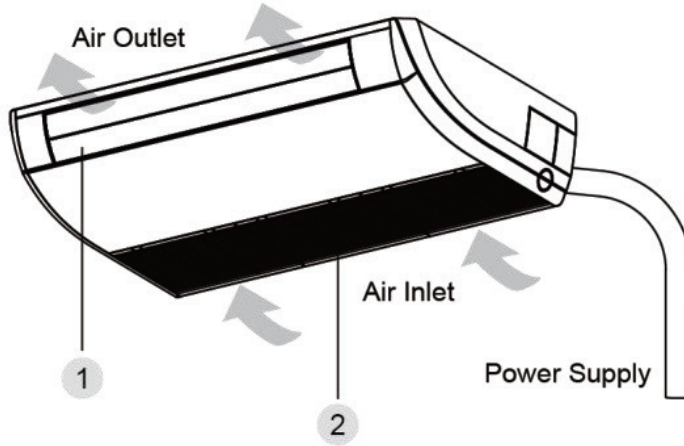

- 1. Guide louver
- 2. Air filter
- 3. Wired controller
- 4. Wireless Controller
- 5. Binding tape
- 6. Drain Pipe
- 7. Gas Pipe
- 8. Lipuid Pipe
- 9. Big Handle
- 10. Front Board

Outdoor

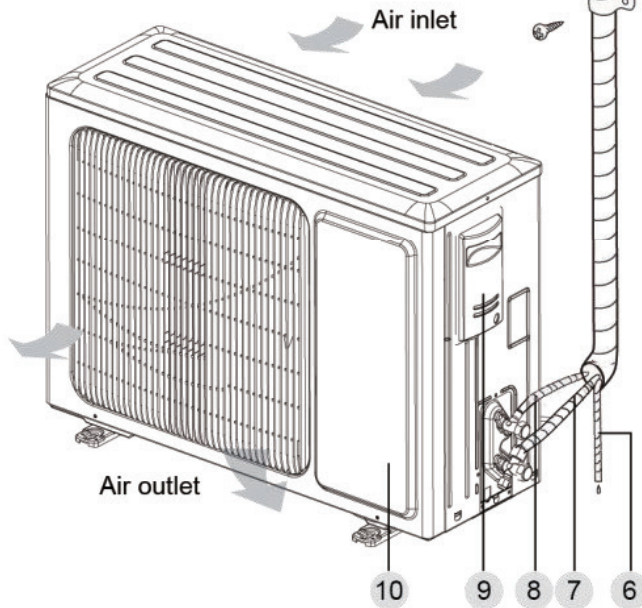

Notes: The connection pipe and duct for this unit should be prepared by the user.

8. Maintenance

8.1 Error Code List

NO.	Malfunction Name	Display Method of Indoor Unit			A/C status	Possible Causes	
		Dual-8 Code Display	Indicator Display (during blinking, ON 0.5s and OFF 0.5s)	Operation Indicator			Cool Indicator
1	High pressure protection of system	E1				During cooling and drying operation, except indoor fan operates, all loads stop operation. During heating operation, the complete unit stops.	Possible reasons: 1. Refrigerant was superabundant; 2. Poor heat exchange (including filth blockage of heat exchanger and bad radiating environment); Ambient temperature is too high.
2	Antifreezing protection	E2				During cooling and drying operation, compressor and outdoor fan stop while indoor fan operates.	1. Poor air-return in indoor unit; 2. Fan speed is abnormal; 3. Evaporator is dirty.
3	System block or refrigerant leakage	E3				The Dual-8 Code Display will show E3 until the low pressure switch stop operation.	1.Low-pressure protection 2.Low-pressure protection of system 3.Low-pressure protection of compressor
4	High discharge temperature protection of compressor	E4				During cooling and drying operation, compressor and outdoor fan stop while indoor fan operates. During heating operation, all loads stop.	Please refer to the malfunction analysis (discharge protection, overload).
5	Overcurrent protection	E5				During cooling and drying operation, compressor and outdoor fan stop while indoor fan operates. During heating operation, all loads stop.	1. Supply voltage is unstable; 2. Supply voltage is too low and load is too high; 3. Evaporator is dirty.
6	Communication Malfunction	E6				During cooling operation, compressor stops while indoor fan motor operates. During heating operation, the complete unit stops.	Refer to the corresponding malfunction analysis.
7	High temperature resistant protection	E8				During cooling operation: compressor will stop while indoor fan will operate. During heating operation, the complete unit stops.	Refer to the malfunction analysis (overload, high temperature resistant).
8	EEPROM malfunction	EE				During cooling and drying operation, compressor will stop while indoor fan will operate; During heating operation, the complete unit will stop	Replace outdoor control panel AP1
9	Limit/decrease frequency due to high temperature of module	EU				All loads operate normally, while operation frequency for compressor is decreased	Discharging after the complete unit is de-energized for 20mins, check whether the thermal grease on IPM Module of outdoor control panel AP1 is sufficient and whether the radiator is inserted tightly. If its no use, please replace control panel AP1.
10	Malfunction protection of jumper cap	C5				Wireless remote receiver and button are effective, but can not dispose the related command	1. No jumper cap insert on mainboard. 2. Incorrect insert of jumper cap. 3. Jumper cap damaged. 4. Abnormal detecting circuit of mainboard.

NO.	Malfunction Name	Display Method of Indoor Unit			A/C status	Possible Causes	
		Dual-8 Code Display	Indicator Display (during blinking, ON 0.5s and OFF 0.5s)				
			Operation Indicator	Cool Indicator			Heating Indicator
11	Gathering refrigerant	F0				When the outdoor unit receive signal of Gathering refrigerant ,the system will be forced to run under cooling mode for gathering refrigerant	Nominal cooling mode
12	Indoor ambient temperature sensor is open/short circuited	F1				During cooling and drying operation, indoor unit operates while other loads will stop; during heating operation, the complete unit will stop operation.	<ol style="list-style-type: none"> 1. Loosening or bad contact of indoor ambient temp. sensor and mainboard terminal. 2. Components in mainboard fell down leads short circuit. 3. Indoor ambient temp. sensor damaged.(check with sensor resistance value chart) 4. Mainboard damaged.
13	Indoor evaporator temperature sensor is open/short circuited	F2				AC stops operation once reaches the setting temperature. Cooling, drying: internal fan motor stops operation while other loads stop operation; heating: AC stop operation	<ol style="list-style-type: none"> 1. Loosening or bad contact of Indoor evaporator temp. sensor and mainboard terminal. 2. Components on the mainboard fall down leads short circuit. 3. Indoor evaporator temp. sensor damaged.(check temp. sensor value chart for testing) 4. Mainboard damaged.
14	Outdoor ambient temperature sensor is open/short circuited	F3				During cooling and drying operating, compressor stops while indoor fan operates; During heating operation, the complete unit will stop operation	Outdoor temperature sensor hasnt been connected well or is damaged. Please check it by referring to the resistance table for temperature sensor)
15	Outdoor condenser temperature sensor is open/short circuited	F4				During cooling and drying operation, compressor stops while indoor fan will operate; During heating operation, the complete unit will stop operation.	Outdoor temperature sensor hasnt been connected well or is damaged. Please check it by referring to the resistance table for temperature sensor)
16	Outdoor discharge temperature sensor is open/short circuited	F5				During cooling and drying operation, compressor will sop after operating for about 3 mins, while indoor fan will operate; During heating operation, the complete unit will stop after operating for about 3 mins.	<ol style="list-style-type: none"> 1.Outdoor temperature sensor hasnt been connected well or is damaged. Please check it by referring to the resistance table for temperature sensor) 2.The head of temperature sensor hasnt been inserted into the copper tube
17	Limit/ decrease frequency due to overload	F6				All loads operate normally, while operation frequency for compressor is decreased	Refer to the malfunction analysis (overload, high temperature resistant)
18	Decrease frequency due to overcurrent	F8				All loads operate normally, while operation frequency for compressor is decreased	The input supply voltage is too low; System pressure is too high and overload

NO.	Malfunction Name	Display Method of Indoor Unit			A/C status	Possible Causes	
		Dual-8 Code Display	Indicator Display (during blinking, ON 0.5s and OFF 0.5s)				
			Operation Indicator	Cool Indicator			Heating Indicator
19	Decrease frequency due to high air discharge	F9				All loads operate normally, while operation frequency for compressor is decreased	Overload or temperature is too high; Refrigerant is insufficient; Malfunction of electric expansion valve (EKV)
20	Limit/ decrease frequency due to antifreezing	FH				All loads operate normally, while operation frequency for compressor is decreased	Poor air-return in indoor unit or fan speed is too low
21	Voltage for DC bus-bar is too high	PH				During cooling and drying operation, compressor will stop while indoor fan will operate; During heating operation, the complete unit will stop operation.	1. Measure the voltage of position L and N on wiring board (XT), if the voltage is higher than 265VAC, turn on the unit after the supply voltage is increased to the normal range. 2.If the AC input is normal, measure the voltage of electrolytic capacitor C on control panel (AP1), if its normal, theres malfunction for the circuit, please replace the control panel (AP1)
22	Voltage of DC bus-bar is too low	PL				During cooling and drying operation, compressor will stop while indoor fan will operate; During heating operation, the complete unit will stop	1. Measure the voltage of position L and N on wiring board (XT), if the voltage is higher than 150VAC, turn on the unit after the supply voltage is increased to the normal range. 2.If the AC input is normal, measure the voltage of electrolytic capacitor C on control panel (AP1), if its normal, theres malfunction for the circuit, please replace the control panel (AP1)
23	Compressor Min frequency in test state	P0					Showing during min. cooling or min. heating test
24	Compressor rated frequency in test state	P1					Showing during nominal cooling or nominal heating test
25	Compressor maximum frequency in test state	P2					Showing during max. cooling or max. heating test

NO.	Malfunction Name	Display Method of Indoor Unit				A/C status	Possible Causes
		Dual-8 Code Display	Indicator Display (during blinking, ON 0.5s and OFF 0.5s)				
			Operation Indicator	Cool Indicator	Heating Indicator		
26	Compressor intermediate frequency in test state	P3					Showing during middle cooling or middle heating test
27	Overcurrent protection of phase current for compressor	P5				During cooling and drying operation, compressor will stop while indoor fan will operate; During heating operation, the complete unit will stop operation.	Refer to the malfunction analysis (IPM protection, loss of synchronism protection and overcurrent protection of phase current for compressor.
28	Charging malfunction of capacitor	PU				During cooling and drying operation, compressor will stop while indoor fan will operate; During heating operation, the complete unit will stop	Refer to the part three—charging malfunction analysis of capacitor
29	Malfunction of module temperature sensor circuit	P7				During cooling and drying operation, compressor will stop while indoor fan will operate; During heating operation, the complete unit will stop	Replace outdoor control panel AP1
30	Module high temperature protection	P8				During cooling operation, compressor will stop while indoor fan will operate; During heating operation, the complete unit will stop	After the complete unit is de-energized for 20mins, check whether the thermal grease on IPM Module of outdoor control panel AP1 is sufficient and whether the radiator is inserted tightly. If its no use, please replace control panel AP1.
31	Overload protection for compressor	H3				During cooling and drying operation, compressor will stop while indoor fan will operate; During heating operation, the complete unit will stop operation.	1. Wiring terminal OVC-COMP is loosened. In normal state, the resistance for this terminal should be less than 1ohm. 2.Refer to the malfunction analysis (discharge protection, overload)
32	IPM protection	H5				During cooling and drying operation, compressor will stop while indoor fan will operate; During heating operation, the complete unit will stop operation.	Refer to the malfunction analysis (IPM protection, loss of synchronism protection and overcurrent protection of phase current for compressor.
33	Desynchronizing of compressor	H7				During cooling and drying operation, compressor will stop while indoor fan will operate; During heating operation, the complete unit will stop operation.	Refer to the malfunction analysis (IPM protection, loss of synchronism protection and overcurrent protection of phase current for compressor.
34	PFC protection	HC				During cooling and drying operation, compressor will stop while indoor fan will operate; During heating operation, the complete unit will stop operation.	Replace outdoor control panel AP1 or Reactor

NO.	Malfunction Name	Display Method of Indoor Unit			A/C status	Possible Causes	
		Dual-8 Code Display	Indicator Display (during blinking, ON 0.5s and OFF 0.5s)				
			Operation Indicator	Cool Indicator	Heating Indicator		
35	Outdoor DC fan motor malfunction	L3				Outdoor DC fan motor malfunction lead to compressor stop operation,	DC fan motor malfunction or system blocked or the connector loosed
36	power protection	L9				compressor stop operation and Outdoor fan motor will stop 30s latter , 3 minutes latter fan motor and compressor will restart	To protect the electronical components when detect high power
37	Indoor unit and outdoor unit doesnt match	LP				compressor and Outdoor fan motor cant work	Indoor unit and outdoor unit doesnt match
38	Failure start-up	LC				During cooling and drying operation, compressor will stop while indoor fan will operate; During heating operation, the complete unit will stop operation.	Refer to the malfunction analysis
39	Defrosting				OFF 3S and blink once (during blinking, ON 10s and OFF 0.5s)	Defrosting will occur in heating mode. Compressor will operate while indoor fan will stop operation.	Its the normal state
40	Malfunction of phase current detection circuit for compressor	U1				During cooling and drying operation, compressor will stop while indoor fan will operate; During heating operation, the complete unit will stop	Replace outdoor control panel AP1
41	Malfunction of voltage dropping for DC bus-bar	U3				During cooling and drying operation, compressor will stop while indoor fan will operate; During heating operation, the complete unit will stop	Supply voltage is unstable
42	Malfunction of complete units current detection	U5				During cooling and drying operation, the compressor will stop while indoor fan will operate; During heating operating, the complete unit will stop operation.	Theres circuit malfunction on outdoor units control panel AP1, please replace the outdoor units control panel AP1.
43	The four-way valve is abnormal	U7				If this malfunction occurs during heating operation, the complete unit will stop operation.	1.Supply voltage is lower than AC175V; 2.Wiring terminal 4V is loosened or broken; 3.4V is damaged, please replace 4V.
44	Water overflow protection	E9				The complete unit stops	If the condition of full of water is detected for 8s, water overflow protection will be enabled and wired controller will display E9 and give an alarm; in each mode, if system enters water overflow protection, indoor units will shut down except the water pump and alarm. The capacity output of outdoor units should be adjusted correspondingly.

If malfunction occurs, corresponding code will display and the unit will resume normal until protection or malfunction disappears.

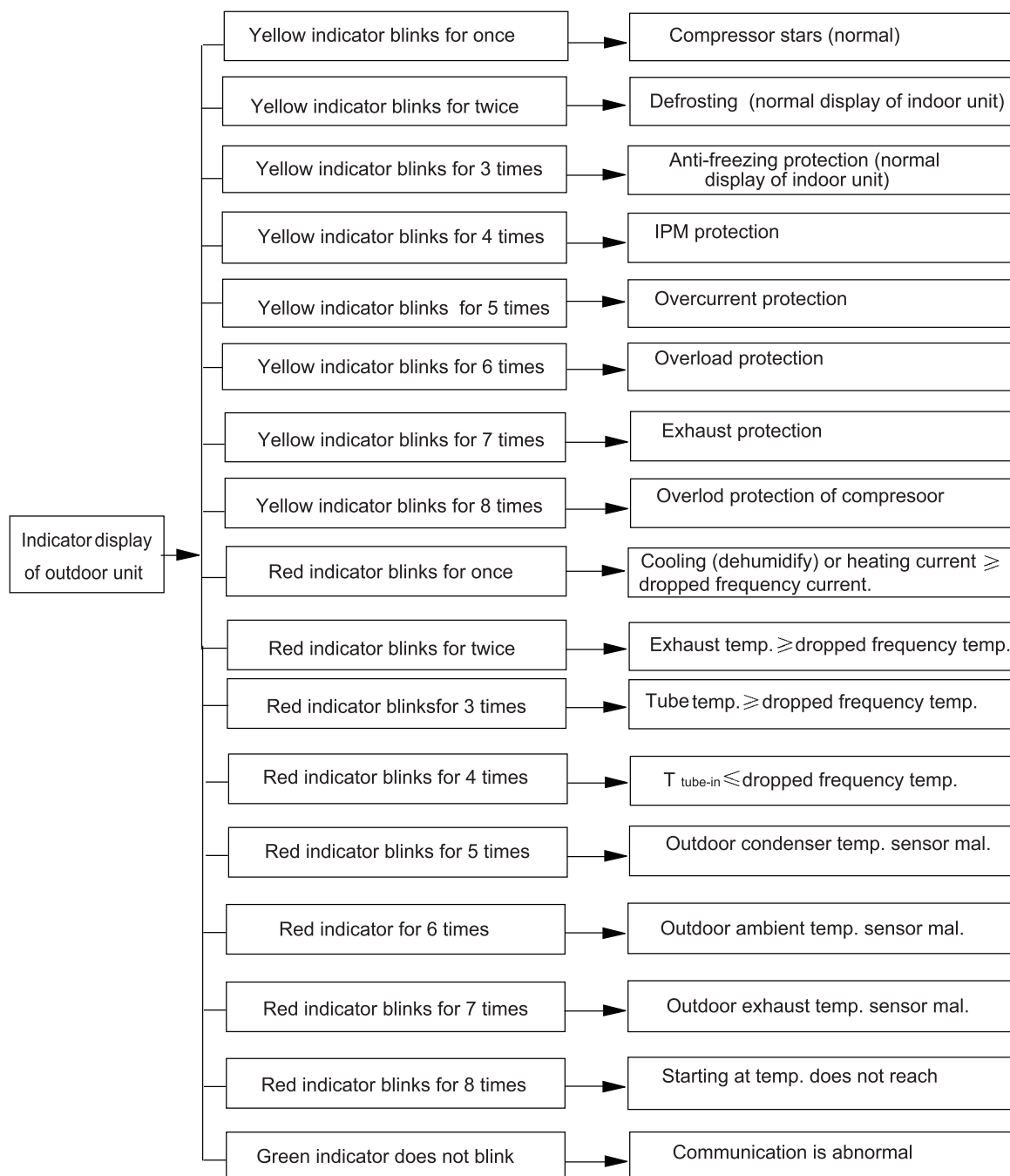

Analysis or processing of some of the malfunction display:

1. Compressor discharge protection

Possible causes: shortage of refrigerant; blockage of air filter; poor ventilation or air flow short pass for condenser; the system has noncondensing gas (such as air, water etc.); blockage of capillary assy (including filter); leakage inside four-way valve causes incorrect operation; malfunction of compressor; malfunction of protection relay; malfunction of discharge sensor; outdoor temperature too high.

Processing method: refer to the malfunction analysis in the above section.

2. Low voltage overcurrent protection

Possible cause: Sudden drop of supply voltage.

3. Communication malfunction

Processing method: Check if communication signal cable is connected reliably.

4. Sensor open or short circuit

Processing method: Check whether sensor is normal, connected with the corresponding position on the controller and if damage of lead wire is found.

5. Compressor over load protection

Possible causes: insufficient or too much refrigerant; blockage of capillary and increase of suction temp.; improper running of compressor, burning in or stuck of bearing, damage of discharge valve; malfunction of protector.

Processing method: adjust refrigerant amount; replace the capillary; replace the compressor; use universal meter to check if the contactor of compressor is fine when it is not overheated, if not replace the protector.

6. System malfunction

i.e. overload protection. When tube temperature (Check the temperature of outdoor heat exchanger when cooling and check the temperature of indoor heat exchanger when heating) is too high, protection will be activated.

Possible causes: Outdoor temperature is too high when cooling; insufficient outdoor air circulation; refrigerant flow malfunction.

please refer to the malfunction analysis in the previous section for handling method.

7. IPM module protection

Processing method: Once the module malfunction happens, if it persists for a long time and can not be self-canceled, cut off the power and turn off the unit, and then re-energize the unit again after about 10 min. After repeating the procedure for several times, if the malfunction still exists, replace the module.

8.2 Troubleshooting for Main Malfunction

Indoor unit:

1. Malfunction of Temperature Sensor F1, F2

Main detection points:

- Is the wiring terminal between the temperature sensor and the controller loosened or poorly contacted?
- Is there short circuit due to trip-over of the parts?
- Is the temperature sensor broken?
- Is mainboard broken?

Malfunction diagnosis process:

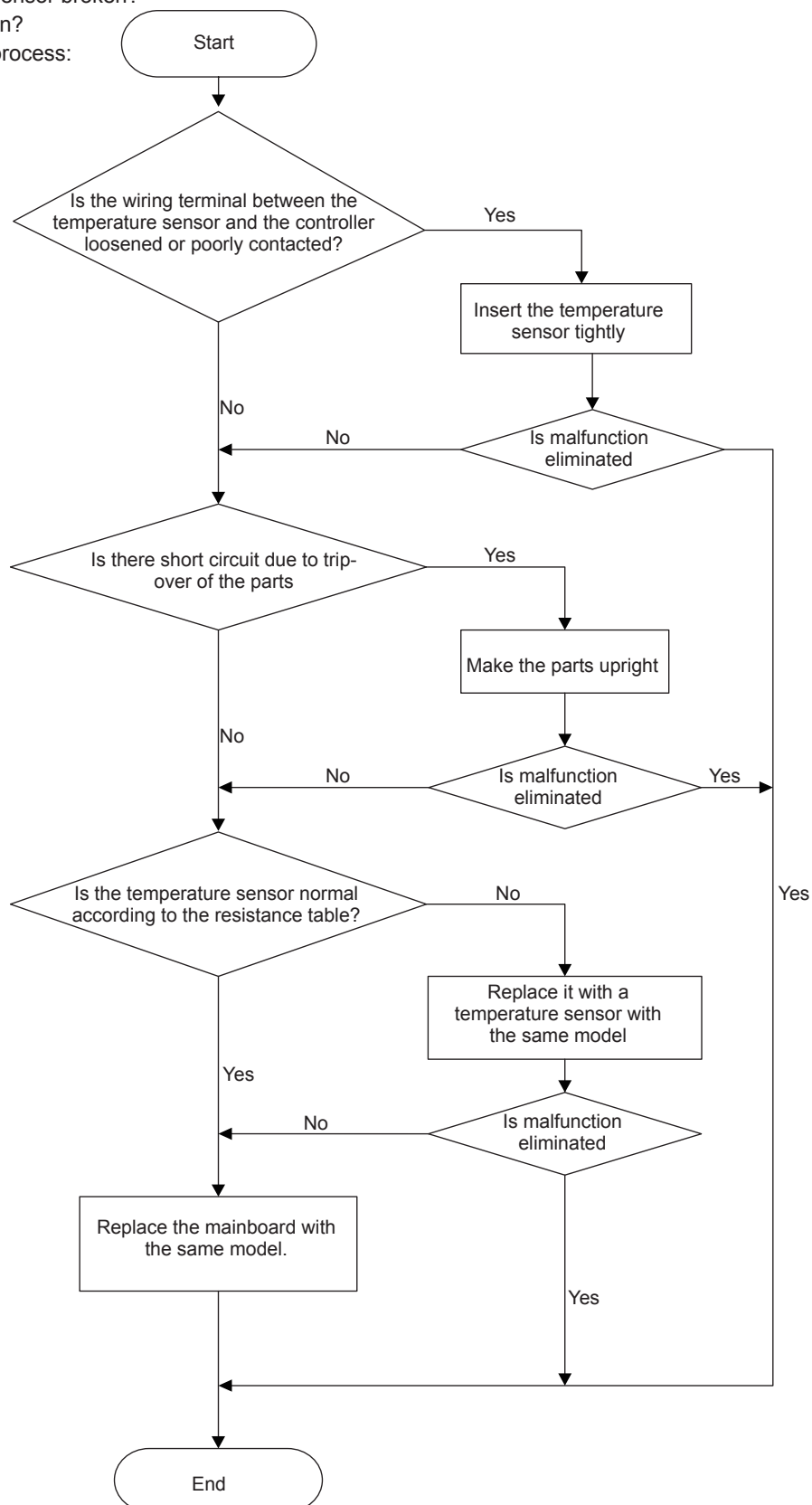

2. Malfunction of Blocked Protection of IDU Fan Motor H6

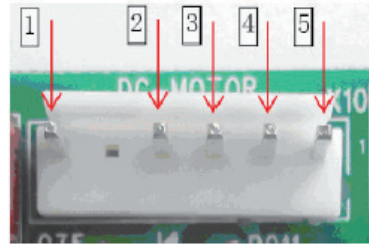
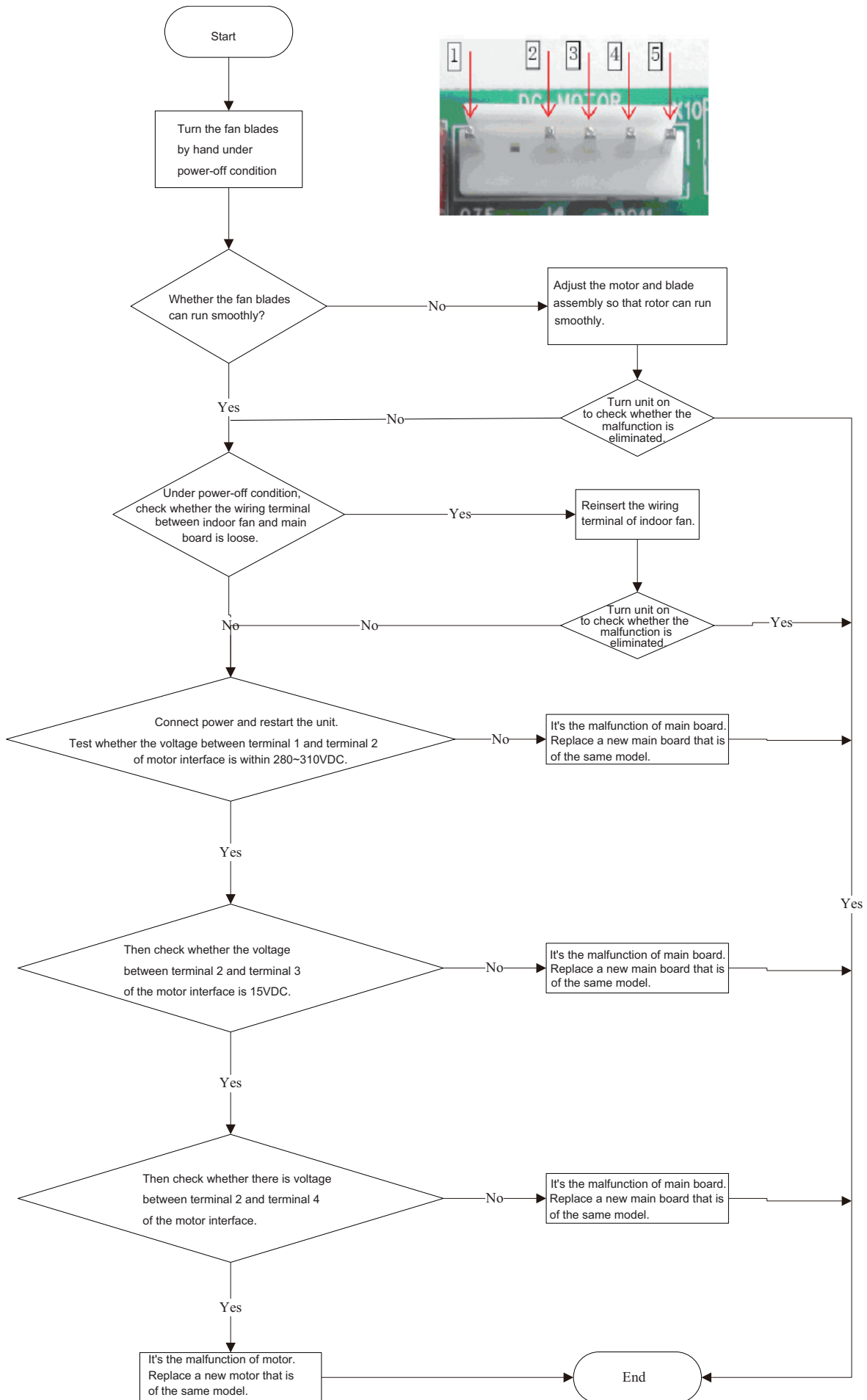

3. Malfunction of Protection of Jumper Cap C5

Main detection points:

- Is there jumper cap on the mainboard?
- Is the jumper cap inserted correctly and tightly?
- The jumper is broken?
- Detection circuit of the mainboard is defined abnormal?

Malfunction diagnosis process:

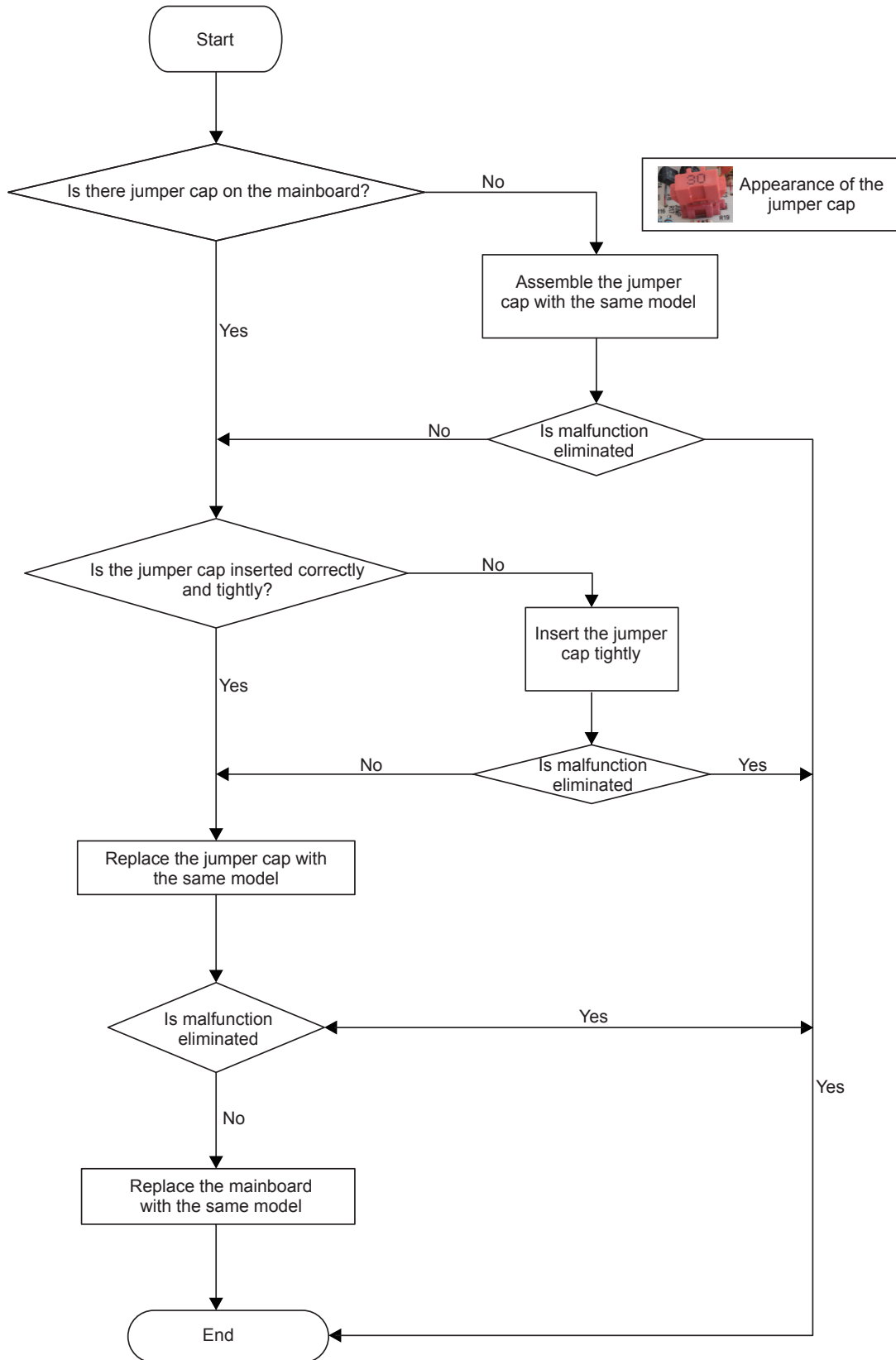

4. Water overflow protection E9

Malfunction diagnosis process:

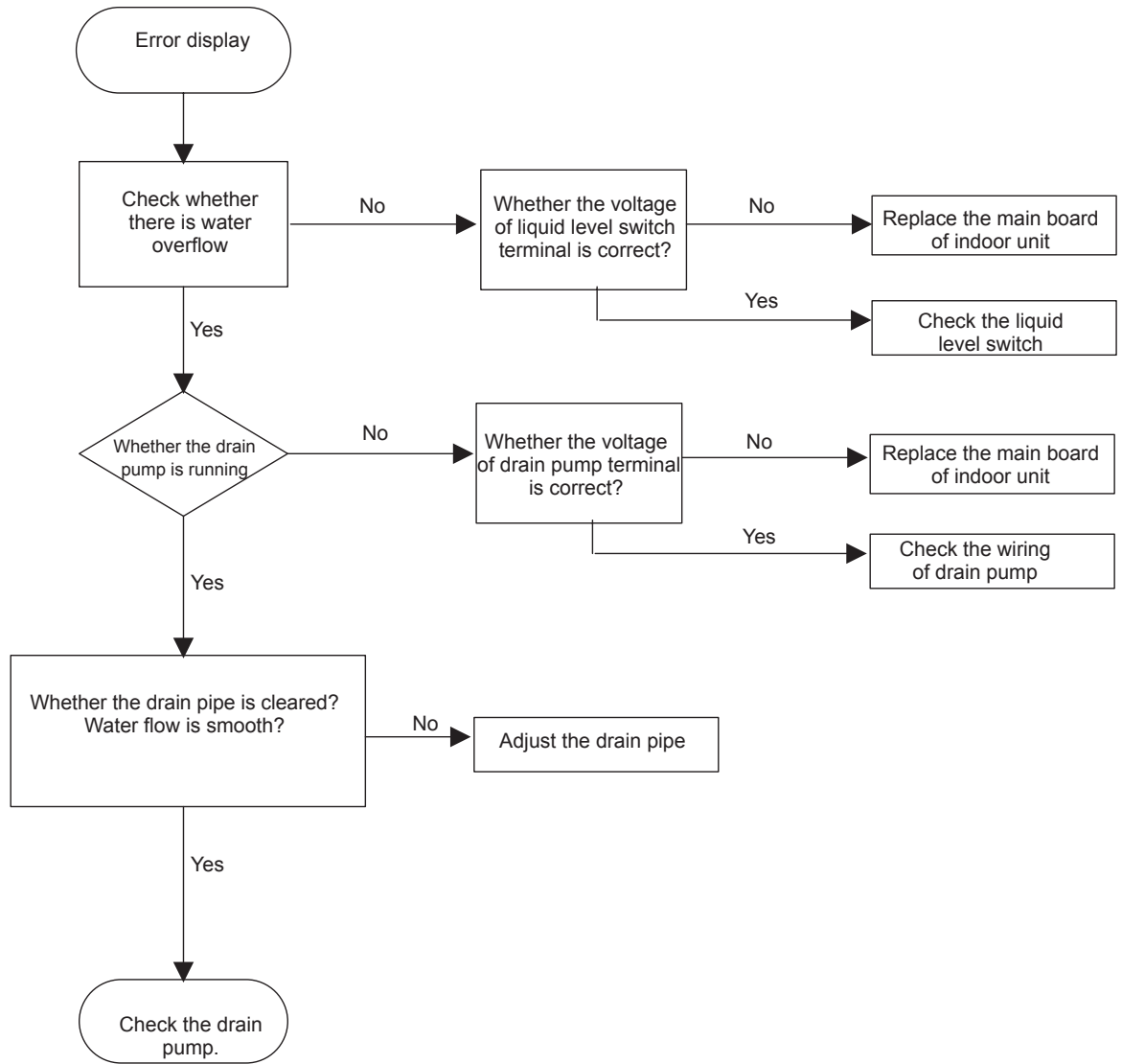

◆ E1 High Pressure Protection

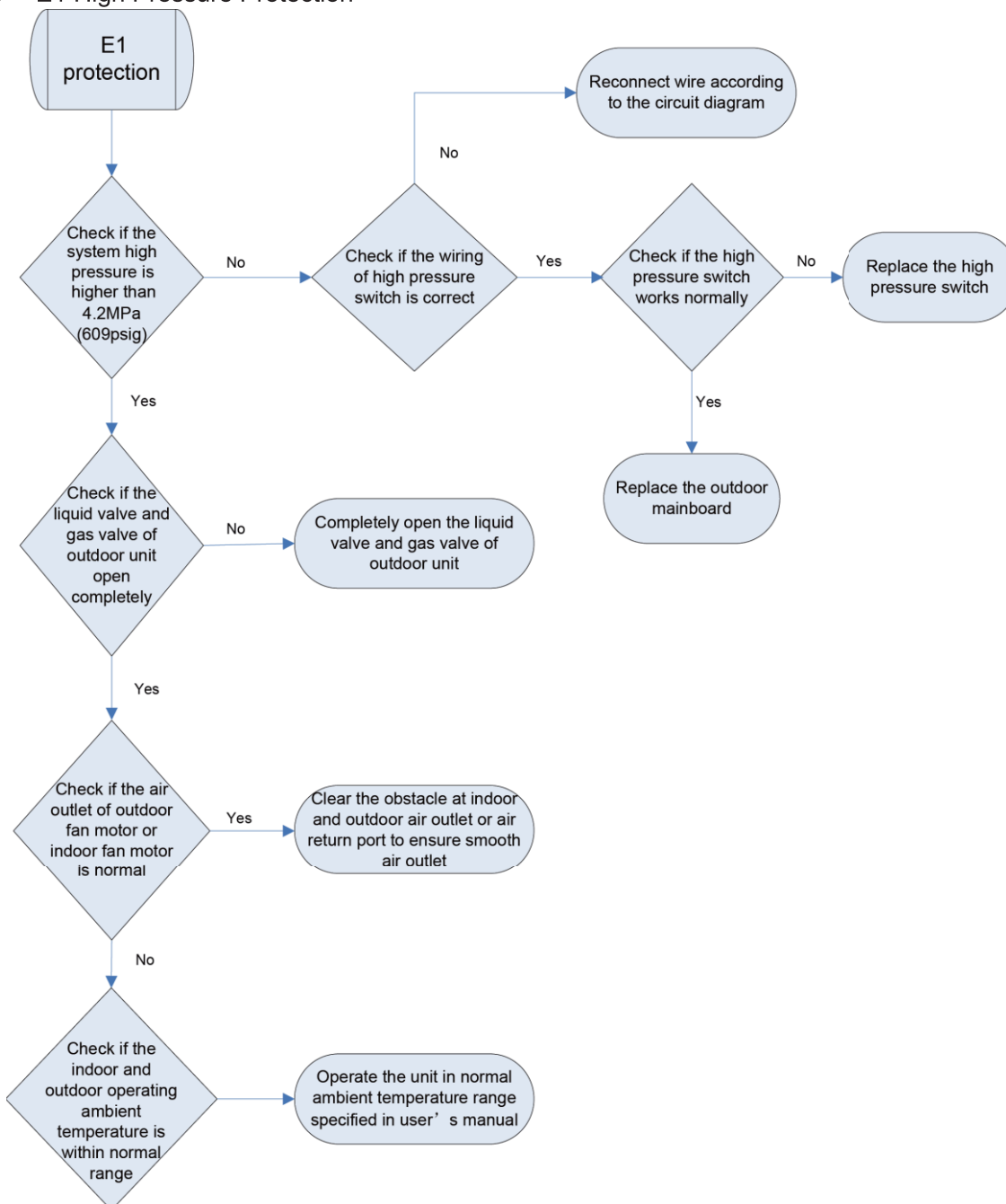

◆ E2 Freeze Protection

Freeze protection is normal protection but not abnormal malfunction. If freeze protection occurs frequently during operation, please check if the indoor filter is with filth blockage or if the indoor air outlet is abnormal. The user is required to clean the filter, check the air outlet and air return pipe periodically to ensure smooth air return and air outlet.

◆ E3 stands for three statuses:

- (1) Low pressure protection;
- (2) Refrigerant lacking protection;
- (3) Refrigerant recycling mode;

R If enter refrigerant recycling mode through special operation, the displayed E3 is not an error code. It will be eliminated when exiting refrigerant recycling mode.

q If you do not want to have refrigerant lacking protection, you can enter the debugging mode through wired controller and then cancel the refrigerant lacking protection mode.

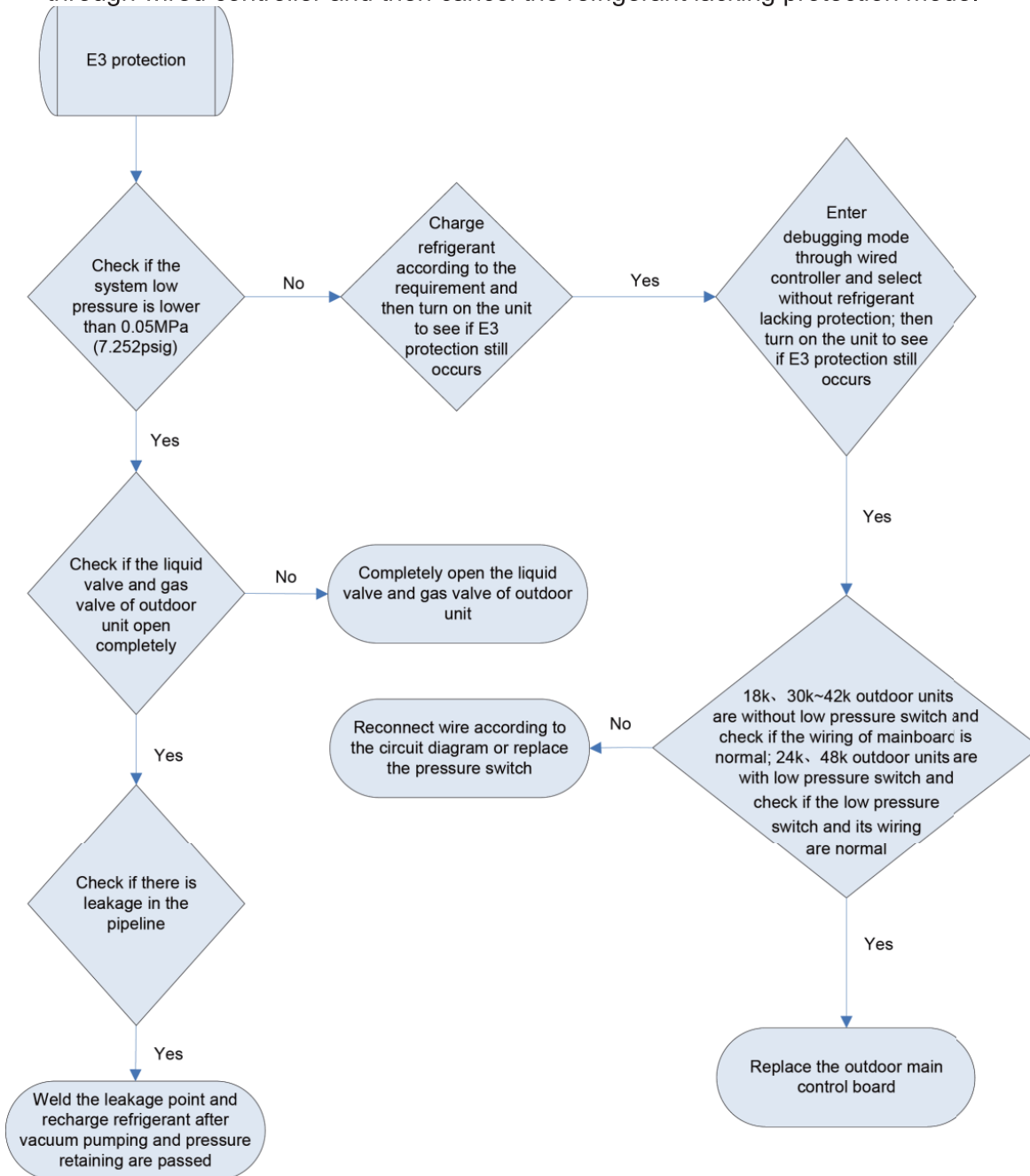

◆ E4 Discharge Protection

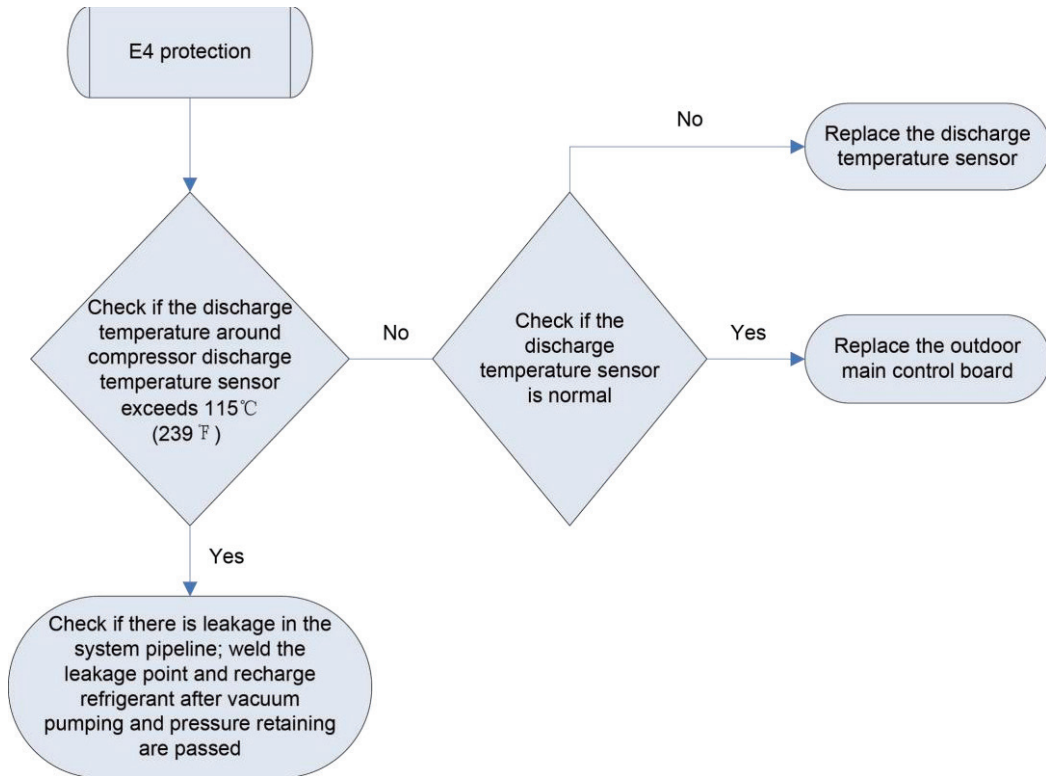

◆ E6 Communication Malfunction

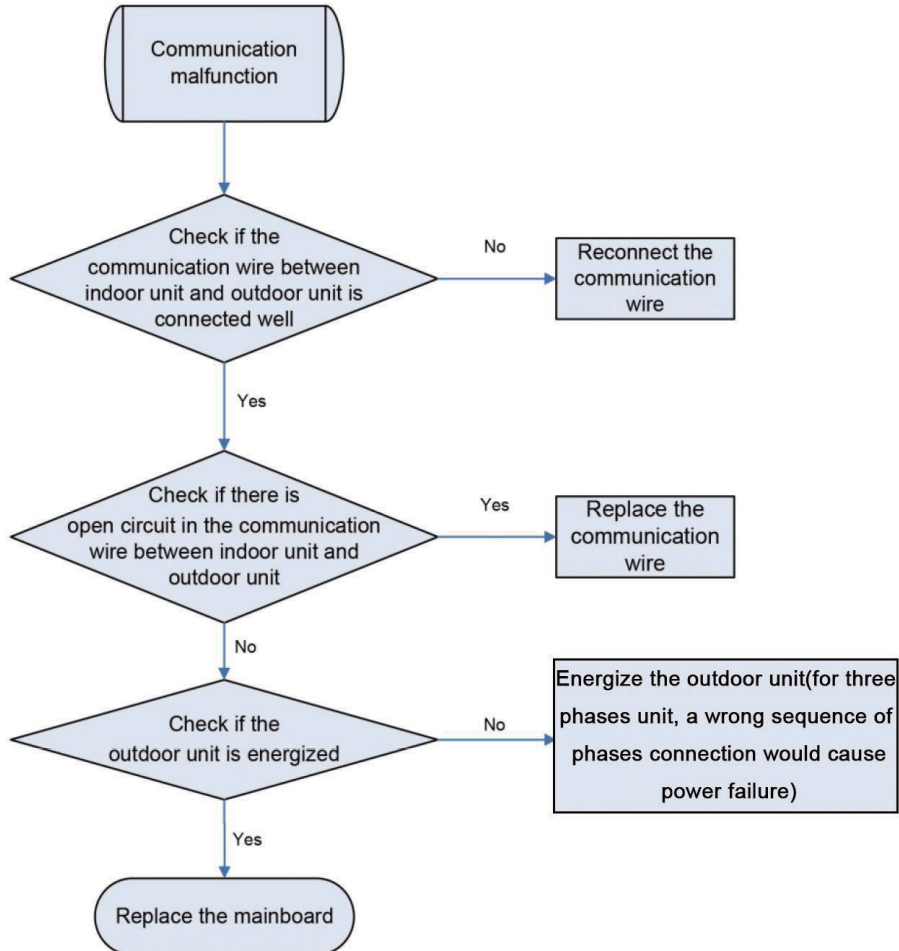

◆ F1 Malfunction of Evaporator Temperature Sensor

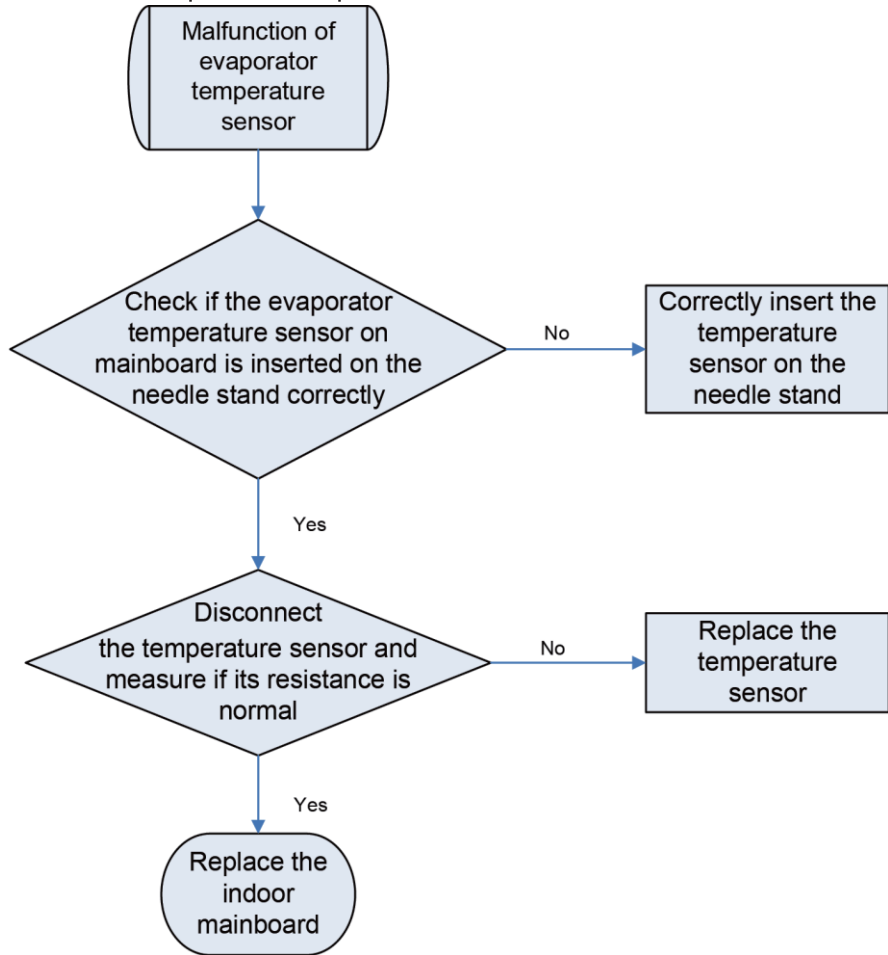

◆ F2 Malfunction of Condenser Temperature Sensor

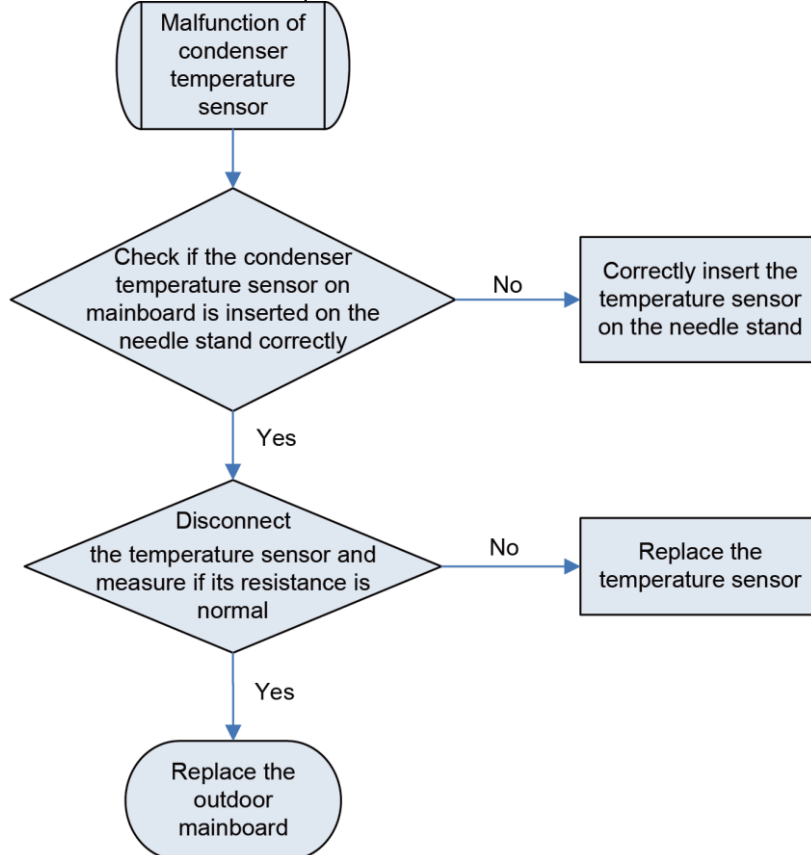

◆ F3 Malfunction of Outdoor Ambient Temperature Sensor

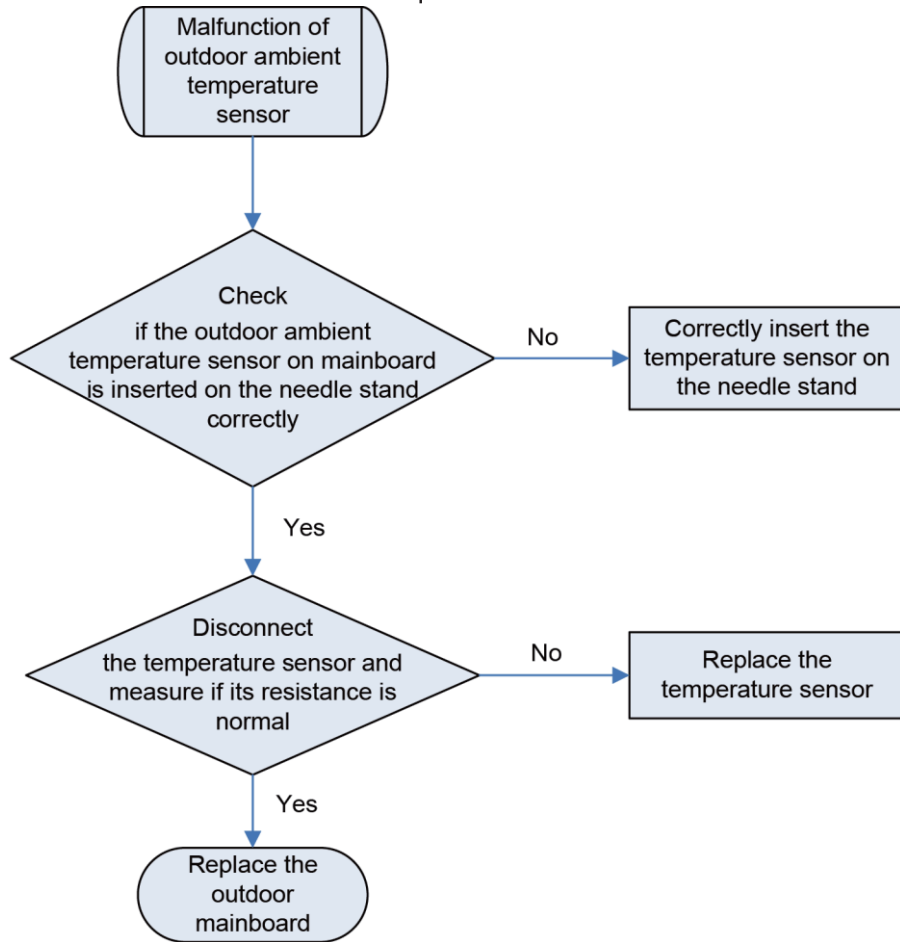

◆ F4 Malfunction of Discharge Temperature Sensor

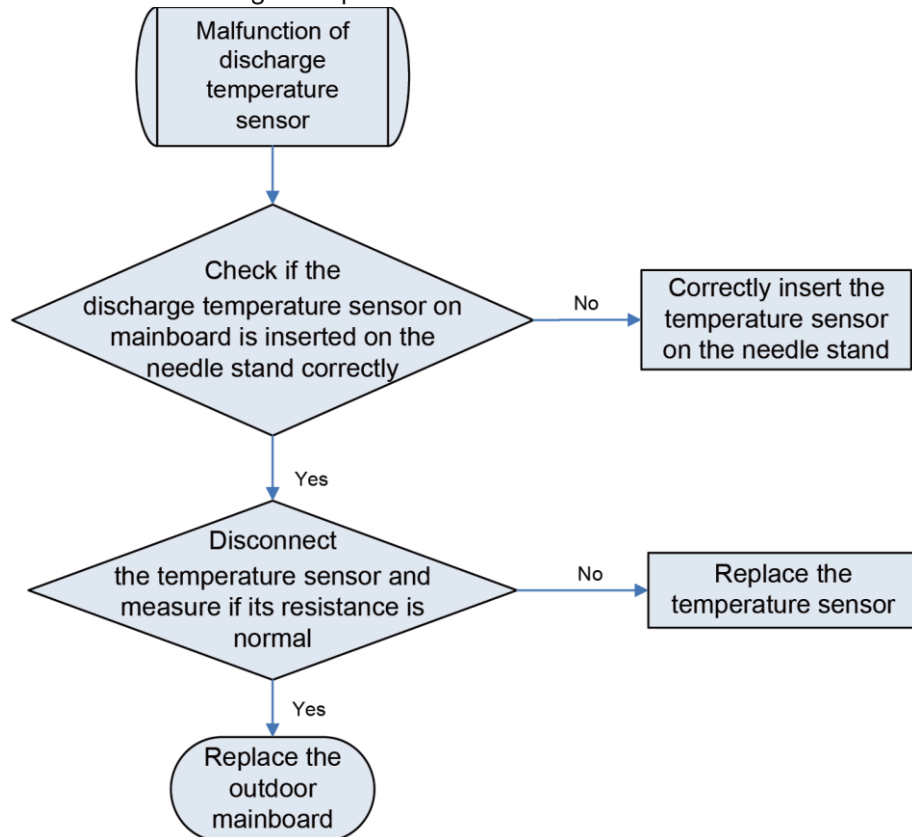

◆ F0 Malfunction of Indoor Ambient Temperature Sensor

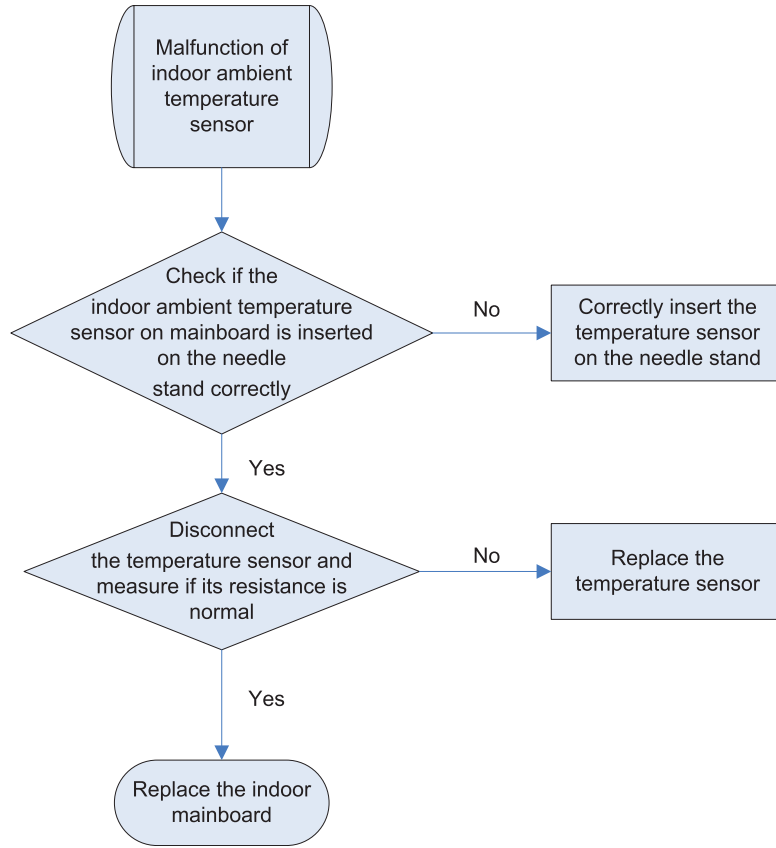

10. Removal Procedure

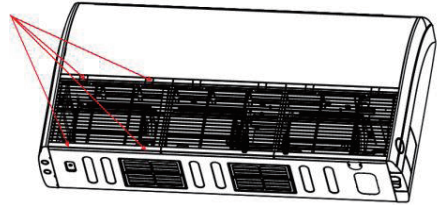
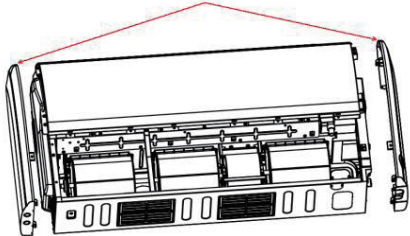
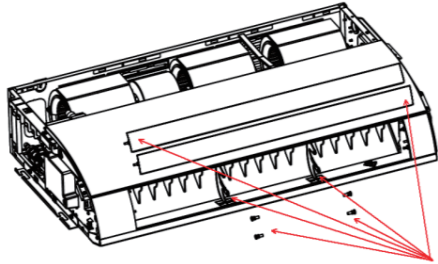
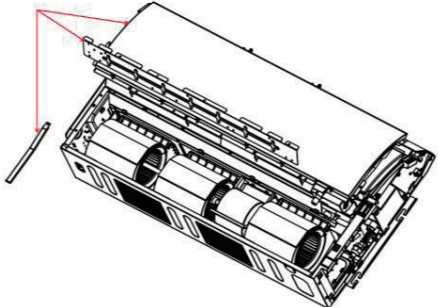

Caution: discharge the refrigerant completely before removal.

Disassembly of panel grating module		
Remark: Make sure that the power supply is cut off before disassembling and protect all the parts during disassembly. Do not put filter screen near the high temperature heat source.		
Step	Illustration	Handling Instruction
Disassembly of sub-assy of front grill		<ul style="list-style-type: none"> •Unscrew the 2 clasps of the upper grill and the 2 screws of the clasps. •Open the grill, disassemble the 2 down clasps to remove the grill.
Disassembly of right and left finishing plates		
Remark: Make sure the power supply is cut off before disassembling and protect all the parts during disassembly. Do not scratch the outer parts.		
Step	Illustration	Handling Instruction
Disassembly of right and left finishing plates		<ul style="list-style-type: none"> •Disassemble the screws as shown in the graph with screwdriver and then push upward to remove the right and left finishing plates. (As is shown in the graph, arrow represents the position of screws.)
Disassembly of panel parts		
Remark: Make sure the power supply is cut off before disassembling and protect all the parts during disassembly. Do not scratch the outer parts.		
Step	Illustration	Handling Instruction
1.Disassembly of sub-assy of air deflecting plate		<ul style="list-style-type: none"> •Remove the air deflecting plates from the air deflecting plate support assembly.
2.Disassembly of panel parts		<ul style="list-style-type: none"> •Unscrew the sides' screws on the cover to remove the cover.

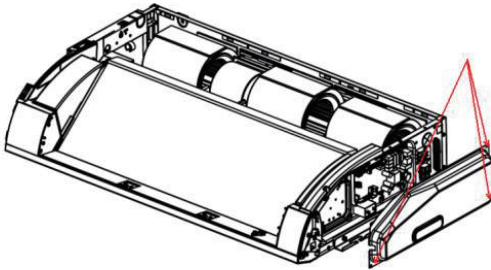
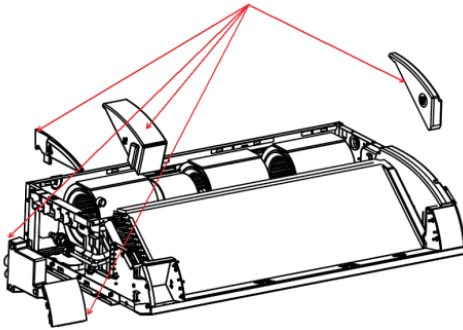
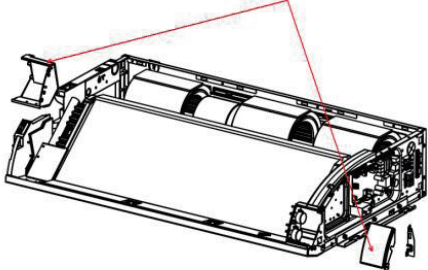
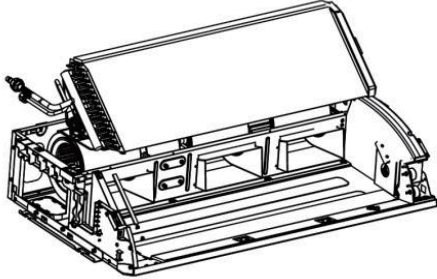
Disassembly of sub-assy of electric box		
Remark: Make sure that the power supply is cut off before disassembling and protect all the parts during disassembly, especially the components inside the box in case of water and hit.		
Step	Illustration	Handling Instruction
Disassembly of electric box cover		<ul style="list-style-type: none"> ●Disassemble 3 screws as shown by the arrow in the graph on left and remove the electric box cover.
Disassemble of foam and cover		
Remark: Make sure the power supply is cut off before disassembling and protect all the parts during disassembly.		
Step	Illustration	Handling Instruction
1.Disassemble of foam		<ul style="list-style-type: none"> ●Remove the foam
2.Disassemble of cover		<ul style="list-style-type: none"> ●Unscrew the screws on the cover to remove the cover.
Disassembly of evaporator components		
Remark: Make sure that the power supply is cut off and protect the copper tube and aluminum fin. If the time for disassembly shall be long, seal the copper tube.		
Step	Illustration	Handling Instruction
Disassembly of evaporator components		<ul style="list-style-type: none"> ●Unscrew the screws of evaporator to remove the evaporator.

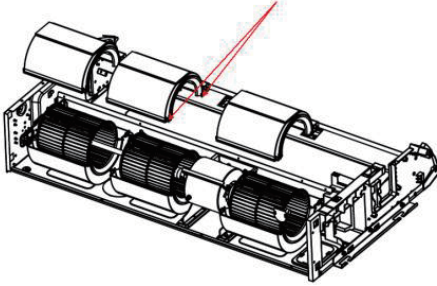
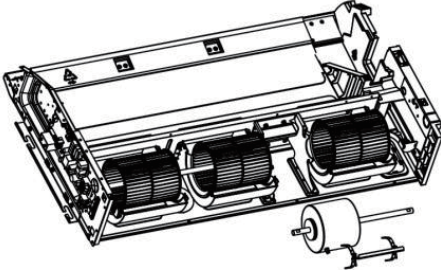
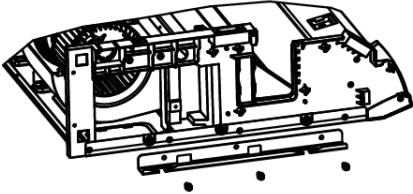
Disassembly of fan and motor components		
Remark: Make sure that the power supply is cut off before disassembling and protect all the parts during disassembly, especially the fastening screws for fans.		
Step	Illustration	Handling Instruction
1. Disassembly of front and back scroll cases		<ul style="list-style-type: none"> ● Press the buckle at the joints of front and back scroll cases with hands and pull upward to remove the front scroll case. Then remove the screws on the back scroll case. Lift the buckle of back scroll case with hands and remove it. (As is shown in the graph, circle represents 2 screws on left and right.)
2. Disassembly of motor		<ul style="list-style-type: none"> ● Loosen the 2 screws of the motor attaching clamp, remove the motor attaching clamp and motor attaching clamp subassembly to remove the motor.
Disassembly of right and left fixing plates		
Remark: Make sure that the power supply is cut off before disassembling and protect all the parts during disassembly.		
Step	Illustration	Handling Instruction
Disassembly of right and left fixing plates		<ul style="list-style-type: none"> ● Disassemble the bolts on right and left fixing plates with tools. (As is shown by the arrow in the graph.)

PARTS GUIDE

MULTI VARIABLE SERIES

**MV-F09BI, MV-F12BI,
MV-F18BI, MV-F24BI**



MV-F09BI

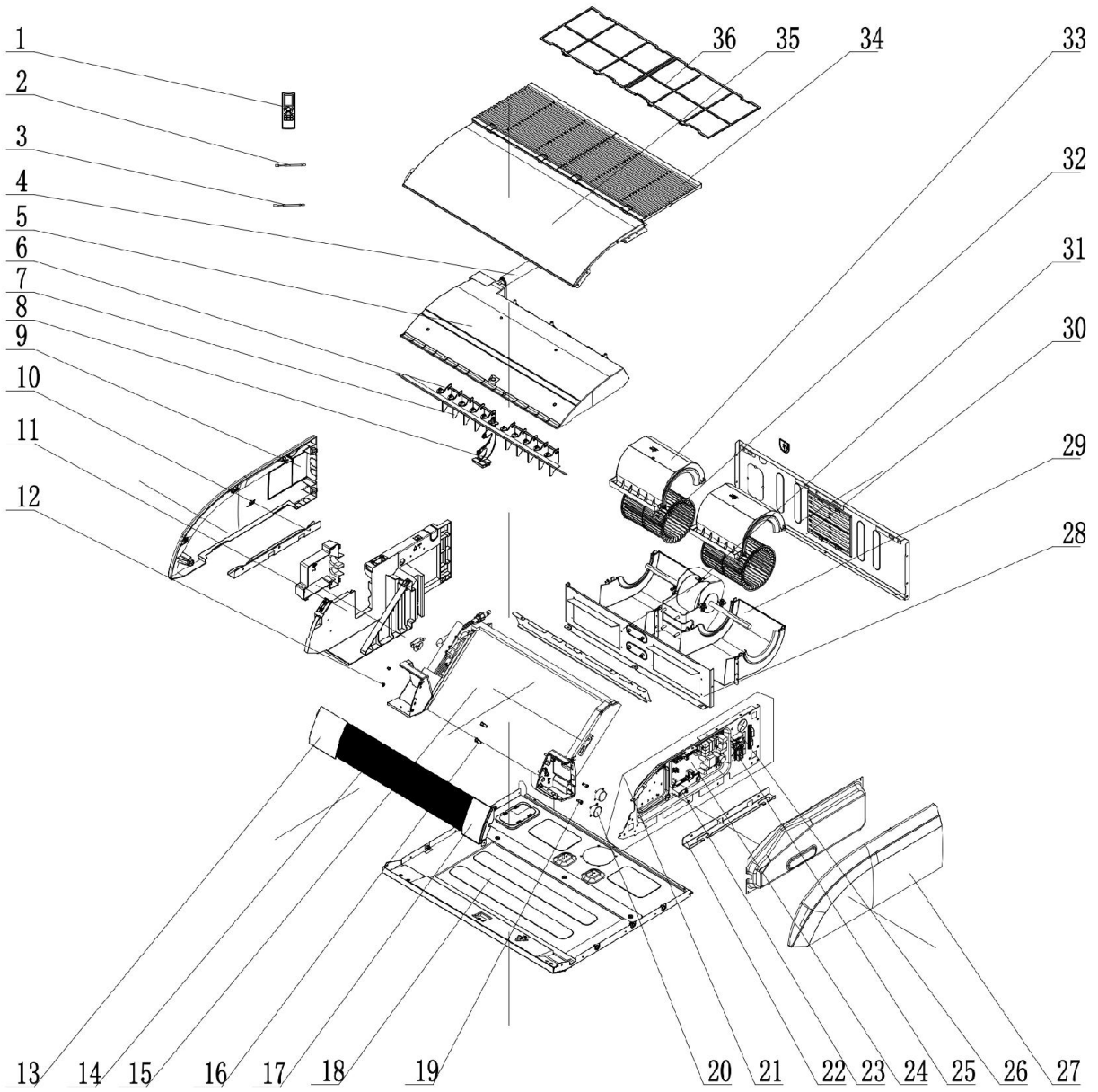

No	Description	Part Code	Note	Qty	Price Code
MODEL: MV-F09BI: FLOOR-CEILING UNIT					
1	Remote Controller	305100491_L41851		1	AT
2	Temperature Sensor	390001923		1	AD
3	Room Sensor	39000191		1	AD
4	Drainage Pipe Sub-assy	05235434		1	AE
5	Water Tray Assy	000069000066		1	AX
6	Swing Lever	10582009		2	AB
7	Air Louver	200007000001		10	AC
8	Supporter	26909400076		1	AD
9	Right Cover Plate	26909400071		1	AN
10	Installation Supporting Frame	01809402		1	AF
11	Right Side Plate	26909400074		1	AM
12	Axile Bush	10542704		2	AB
13	Front Panel	200003000001		1	AL
14	Guide Louver	200004000046		2	AF
15	Evaporator Assy	011001060120		1	BC
16	Rotating Shaft	26909430		2	AB
17	Display Board	30294000009		1	AR
18	Base Plate Assy	011007000032		1	AU
19	Crankshaft	200023000001		2	AB
20	Stepping Motor	1521240206		2	AG
21	Electric Box Assy	100002060574		1	AZ
22	Installation Supporting Frame	01809401		1	AK
23	Capacitor CBB61	3301074716		1	AF
24	Main Board	300002060140		1	AX
25	Terminal Board	none		0	-
26	Terminal Board	420001000002		1	AE
27	Left Cover Plate	26909400070		1	AP
28	Clapboard Sub-Assy	017021000088		1	AK
29	Propeller Housing (Lower)	200230000001		2	AK
30	Rear Side Plate Sub-Assy	017051000046		1	AM
31	Fan Motor	1570940901		1	BA
32	Centifugal Fan	103003000001		2	AM
33	Propeller Housing (Upper)	200230000002		2	AK
34	Front Grill	200226000004		2	AH
35	Top Cover	012148000046P		1	AQ
36	Filter Sub-assy (Rear Side Plate)	111001000001		1	AD

The data are subject to change without notice.

MV-F12BI

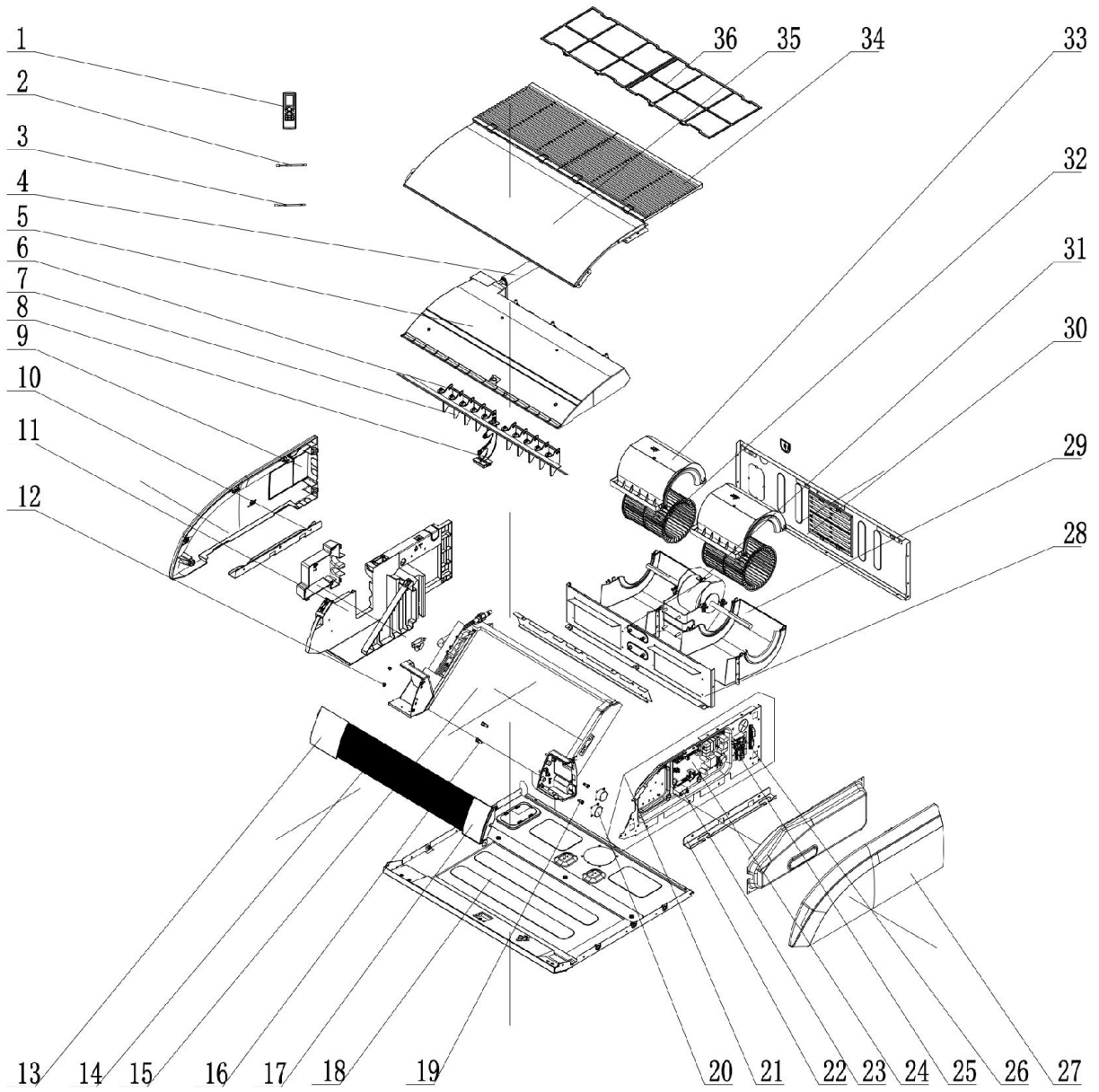

No	Description	Part Code	Note	Qty	Price Code
MODEL: MV-F12BI: FLOOR-CEILING UNIT					
1	Remote Controller	305100491_L41851		1	AT
2	Temperature Sensor	390001923		1	AD
3	Room Sensor	39000191		1	AD
4	Drainage Pipe Sub-assy	05235434		1	AE
5	Water Tray Assy	000069000066		1	AX
6	Swing Lever	10582009		2	AB
7	Air Louver	200007000001		10	AC
8	Supporter	26909400076		1	AD
9	Right Cover Plate	26909400071		1	AN
10	Installation Supporting Frame	01809402		1	AF
11	Right Side Plate	26909400074		1	AM
12	Axile Bush	10542704		2	AB
13	Front Panel	200003000001		1	AL
14	Guide Louver	200004000046		2	AF
15	Evaporator Assy	011001000391		1	BD
16	Rotating Shaft	26909430		2	AB
17	Display Board	30294000009		1	AR
18	Base Plate Assy	011007000032		1	AU
19	Crankshaft	200023000001		2	AB
20	Stepping Motor	1521240206		2	AG
21	Electric Box Assy	100002060573		1	AZ
22	Installation Supporting Frame	01809401		1	AK
23	Capacitor CBB61	3301074716		1	AF
24	Main Board	300002060140		1	AX
25	Terminal Board	none		0	-
26	Terminal Board	420001000002		1	AE
27	Left Cover Plate	26909400070		1	AP
28	Clapboard Sub-Assy	017021000088		1	AL
29	Propeller Housing (Lower)	200230000001		2	AK
30	Rear Side Plate Sub-Assy	017051000046		1	AM
31	Fan Motor	1570940901		1	BA
32	Centifugal Fan	103003000001		2	AM
33	Propeller Housing (Upper)	200230000002		2	AK
34	Front Grill	200226000004		2	AH
35	Top Cover	012148000046P		1	AQ
36	Filter Sub-assy (Rear Side Plate)	111001000001		1	AD

The data are subject to change without notice.

MV-F18BI

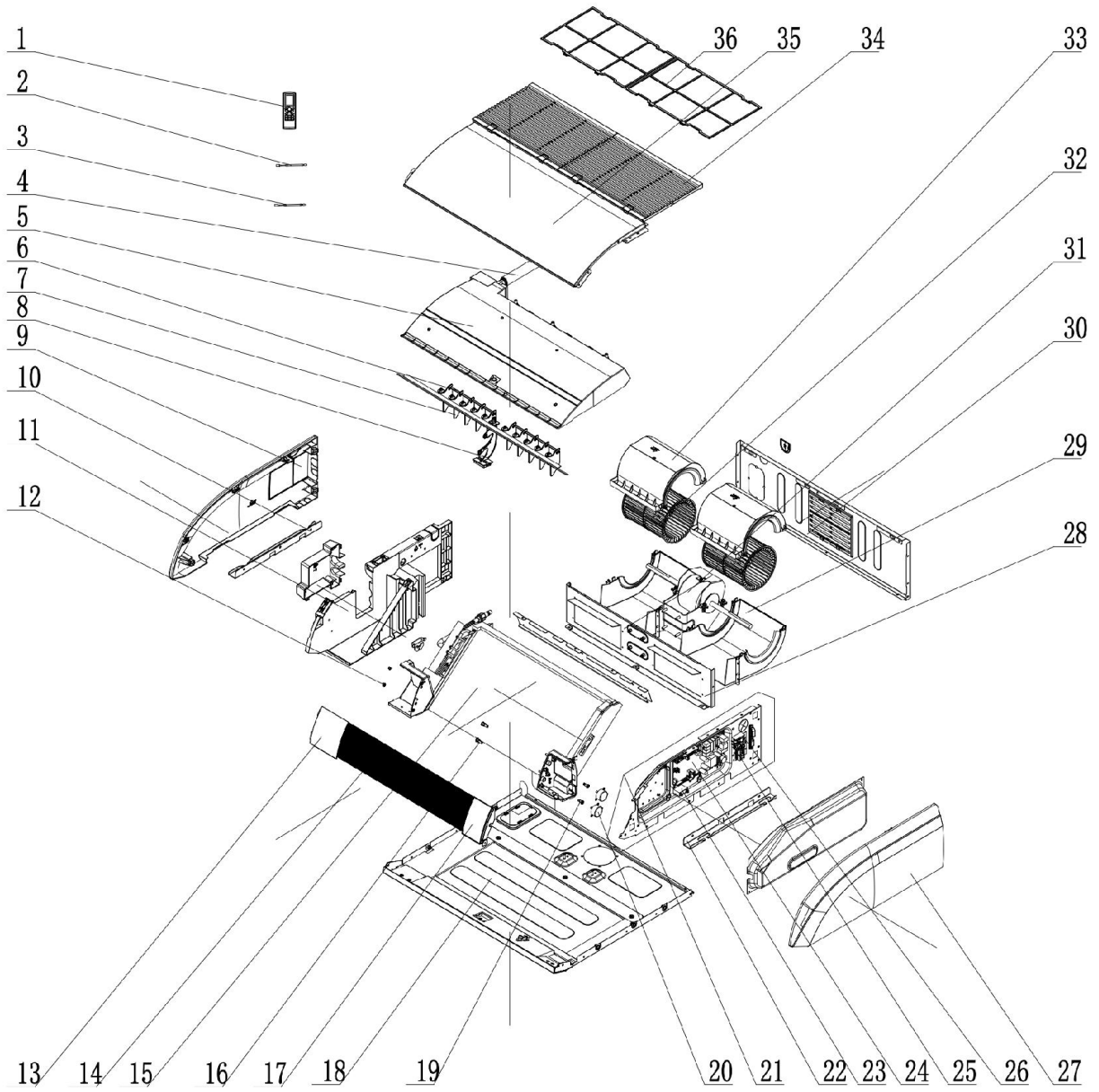

No	Description	Part Code	Note	Qty	Price Code
MODEL: MV-F18BI: FLOOR-CEILING UNIT					
1	Remote Controller	305100491_L41851		1	AT
2	Temperature Sensor	390001923		1	AD
3	Room Sensor	39000191		1	AD
4	Drainage Pipe Sub-assy	05235434		1	AE
5	Water Tray Assy	000069000066		1	AX
6	Swing Lever	10582009		2	AB
7	Air Louver	200007000001		10	AC
8	Supporter	26909400076		1	AD
9	Right Cover Plate	26909400071		1	AN
10	Installation Supporting Frame	01809402		1	AF
11	Right Side Plate	26909400074		1	AM
12	Axile Bush	10542704		2	AB
13	Front Panel	200003000001		1	AC
14	Guide Louver	200004000046		2	AF
15	Evaporator Assy	011001060322		1	BE
16	Rotating Shaft	26909430		2	AB
17	Display Board	30294000009		1	AR
18	Base Plate Assy	011007000032		1	AU
19	Crankshaft	200023000001		2	AB
20	Stepping Motor	1521240206		2	AG
21	Electric Box Assy	100002060572		1	AZ
22	Installation Supporting Frame	01809401		1	AK
23	Capacitor CBB61	3301074716		1	AF
24	Main Board	300002060140		1	AX
25	Terminal Board	none		0	-
26	Terminal Board	420001000002		1	AE
27	Left Cover Plate	26909400070		1	AP
28	Clapboard Sub-Assy	017021000088		1	AL
29	Propeller Housing (Lower)	200230000001		2	AK
30	Rear Side Plate Sub-Assy	017051000046		1	AM
31	Fan Motor	1570940901		1	BA
32	Centifugal Fan	103003000001		2	AM
33	Propeller Housing (Upper)	200230000002		2	AK
34	Front Grill	200226000004		2	AH
35	Top Cover	012148000046P		1	AQ
36	Filter Sub-assy (Rear Side Plate)	111001000001		1	AD

The data are subject to change without notice.

MV-F24BI

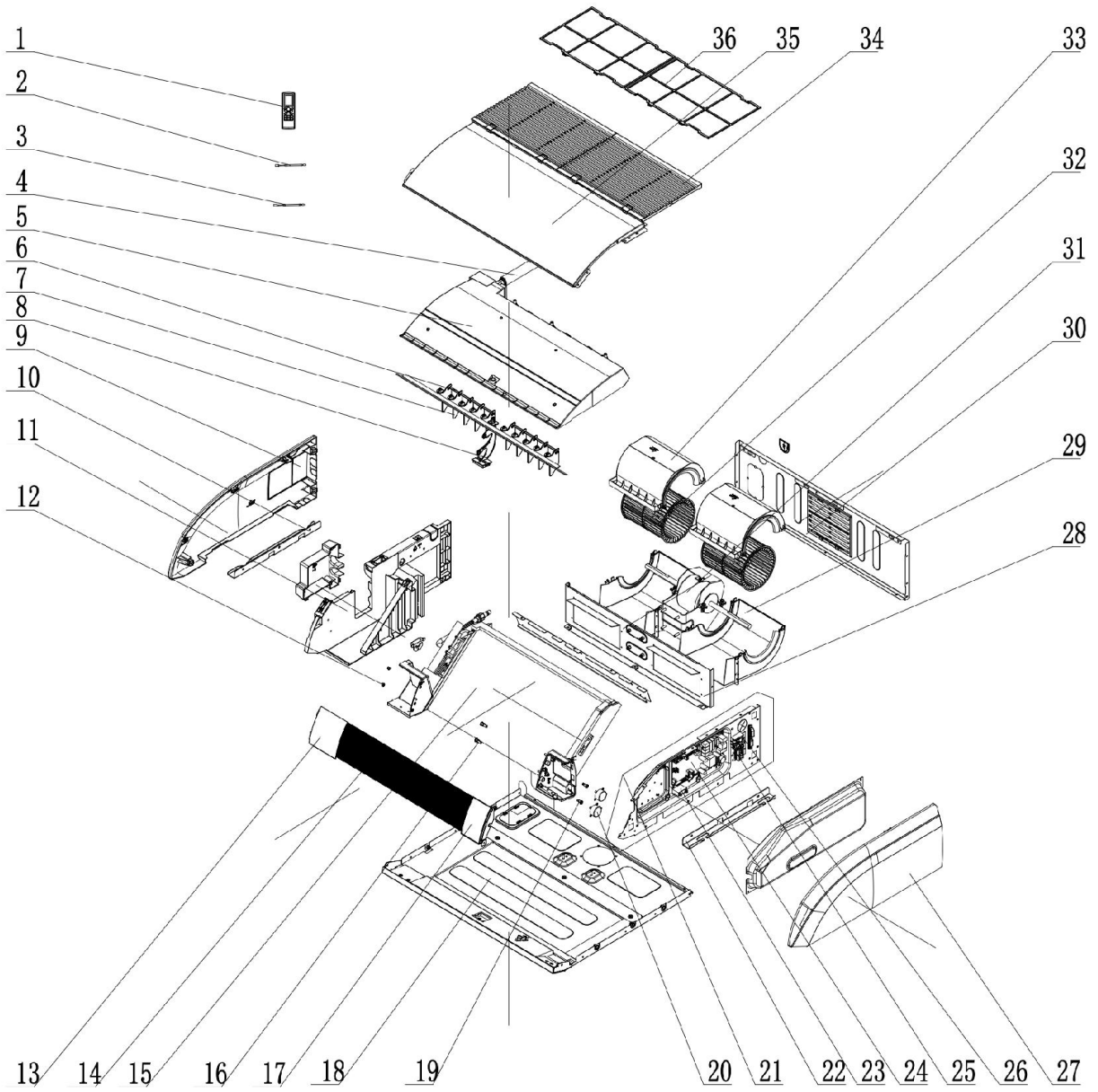

No	Description	Part Code	Note	Qty	Price Code
MODEL: MV-F24BI: FLOOR-CEILING UNIT					
1	Remote Controller	305100491_L41851		1	AT
2	Temperature Sensor	3900019204		1	AD
3	Room Sensor	39000191		1	AD
4	Drainage Pipe Sub-assy	05235434		1	AE
5	Water Tray Assy	01289400017		1	AX
6	Swing Lever	10582009		2	AB
7	Air Louver	200007000001		10	AC
8	Supporter	26909400076		1	AD
9	Right Cover Plate	26909400071		1	AN
10	Installation Supporting Frame	01809402		1	AF
11	Right Side Plate	26909400074		1	AM
12	Axile Bush	10542704		2	AB
13	Front Panel	200003000001		1	AL
14	Guide Louver	200004500422		2	AG
15	Evaporator Assy	011001060117		1	BF
16	Rotating Shaft	26909430		2	AB
17	Display Board	30294000009		1	AR
18	Base Plate Assy	02229400036		1	AX
19	Crankshaft	200023000001		2	AB
20	Stepping Motor	1521240206		2	AG
21	Electric Box Assy	100002060571		1	AZ
22	Installation Supporting Frame	01809401		1	AK
23	Capacitor CBB61S	3301074702		1	AH
24	Main Board	300002060140		1	AX
25	Terminal Board	none		0	-
26	Terminal Board	420001000002		1	AE
27	Left Cover Plate	26909400070		1	AP
28	Clapboard Sub-Assy	01249400018		1	AN
29	Propeller Housing (Lower)	200230000001		2	AK
30	Rear Side Plate Sub-assy	017051000005		1	AP
31	Fan Motor	150101000102		1	BB
32	Centifugal Fan	103003000001		2	AM
33	Propeller Housing (Upper)	200230000002		2	AK
34	Front Grill	26909400072		1	AH
35	Top Cover	01269400012P		1	AV
36	Filter Sub-assy (Rear Side Plate)	111001000001		1	AD

The data are subject to change without notice.

NOTE CONCERNING PROTECTION OF ENVIRONMENT



This product must not be disposed of via normal household waste after its service life, but must be taken to a collection station for the recycling of electrical and electronic devices. The symbol on the product, the operating instructions or the packaging indicate such disposal procedures. The materials are recyclable in accordance with their respective symbols. By means of re-use, material recycling or any other form of recycling old appliances you are making an important contribution to the protection of our environment. Please ask your local council where your nearest disposal station is located.

INFORMATION CONCERNING USED REFRIGERANT MEDIUM

This unit is containing fluorinated gases included in the Kyoto protocol. The maintenance and the liquidation must be carried out by qualified personnel.

Type of refrigerant: R32

The quantity of the refrigerant: please see the unit label.

The value GWP: 675 (1 kg R32 = 0,675 t CO₂ eq)

GWP = Global Warming Potential



Appliance filled with flammable gas R32.

In case of quality problem or other please contact your local supplier or authorized service center.

Emergency number: 112

PRODUCER

SINCLAIR CORPORATION Ltd.

1-4 Argyll St.

London W1F 7LD

Great Britain

www.sinclair-world.com

This product was manufactured in China (Made in China).

REPRESENTATIVE

SINCLAIR Global Group s.r.o.

Purkynova 45

612 00 Brno

Czech Republic

TECHNICAL SUPPORT

SINCLAIR Global Group s.r.o.

Purkynova 45

612 00 Brno

Czech Republic

Tel.: +420 800 100 285

Fax: +420 541 590 124

www.sinclair-solutions.com

info@sinclair-solutions.com

